

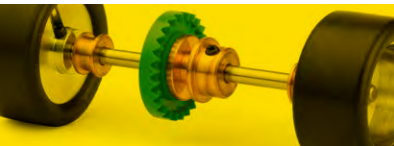

slot CARS ACCESSORIES

1:32·SCALE



slot.it



**Galileo
Engineering**

Galileo Engineering srl
via Cavallotti 16
42122 Reggio Emilia, Italy
E-mail: info@slot.it



Release September 2024



slot.it

Index

- | | | | |
|----|------------------------|----|------------------------------|
| 4 | HRS2 Ready to run | 62 | Magnets |
| 9 | Chassis spares | 62 | Ballast |
| 10 | Cable/Braids/Terminals | 63 | Suspensions |
| 11 | Pickups | 64 | Screwdrivers |
| 14 | Motor configuration | 64 | Screws |
| 16 | Motor mounts | 66 | Cars spare parts |
| 26 | 4WD System | 68 | E-bay shop |
| 28 | Motors | 70 | Vacuum forming cockpits |
| 32 | Pinions | 71 | oXigen Digital System |
| 35 | Extractor/Press | 72 | Digital System |
| 38 | Sidewinder Spur Gears | 76 | Electronic Analog Controller |
| 39 | Modular crown | 78 | Lighting kit |
| 41 | Inline Crown Gears | 79 | Live Timing System |
| 43 | Anglewinder Gears | 80 | D2A System |
| 46 | Starter Kit | 81 | Prints & Posters |
| 48 | Wheels | 81 | Maintenance |
| 53 | Axle and Spacer | 82 | Common Parts |
| 54 | Plastic inserts | 82 | Packaging |
| 60 | Tyres | 83 | Distributors |
| 62 | Bushing & Pulleys | 85 | Stores |



HRS² Chassis

The HRS chassis is a fully configurable, universal plastic chassis for slot cars. It comprises four main parts: main chassis, front chassis, motor mount, and body mounting means.

ADJUSTABLE WHEELBASE

The front chassis can be positioned freely within a wheelbase between 64 and 90 mm.

SELECTABLE FRONT AXLE POSITION

The front axle can be placed in one of two possible positions, one of which completely adjustable, making it easy to adjust the distance from the pickup.

FLEXIBLE ASSEMBLY SYSTEM

The chassis and the body can be joined with either four mounting posts and cups (HRS1 style), two three-posts sidebars, or, on some cars, where possible, with the car's own screw holes.

4

HRS² Ready to run



CH109e

Inline HRS2

Ready to run HRS2 chassis

OFFSET 0.5 mm

19 mm $\odot \longleftrightarrow \odot$ 64/90 mm $\square \longleftrightarrow \square$ 56/61 mm



Ready to run



CH31f

Sidewinder HRS2

Ready to run HRS2 chassis

OFFSET 0.5 mm

19 mm  64/90 mm  57/61 mm

5



CH32f

Anglewinder HRS2

Ready to run HRS2 chassis

OFFSET 1.0 mm

19 mm  64/90 mm  60.6/64 mm

Wheel inserts type may be different



Starter kit



CH34b

Inline HRS2

Chassis starter kit

6

OFFSET: 0.0 mm



CH33b

Sidewinder HRS2

Chassis starter kit

OFFSET: 0.5 mm



Starter kit



CH35

Anglewinder HRS2

Chassis starter kit

OFFSET: 0.0 mm

7



CH36

Chassis-to-body HRS2

connecting cups and spare parts



Spare parts



CH37
Main Inline/ Sidewinder HRS2
Chassis



CH38
Main Anglewinder HRS2
Chassis



8

CH42
Chassis-to-body HRS2
connecting cups - (4x + 2x)



Support to be glued on body

Metric screws for tilting regulation

Support for screws regulation

Grub screws for body alignment and height regulation

8/10 mm grub screws for body-to-chassis distance regulation

CH57b
Body-to-chassis HRS2 adapter

Chassis spares

SP07

Interchangeable spacers

for front axle regulation (2+2+2+2)



CH79b

Chassis common parts



CH50p

Replacement plastic parts for SCX digital



CH72

Plastic retainer nuts (6x)

USE WITH CH51 SCREWS

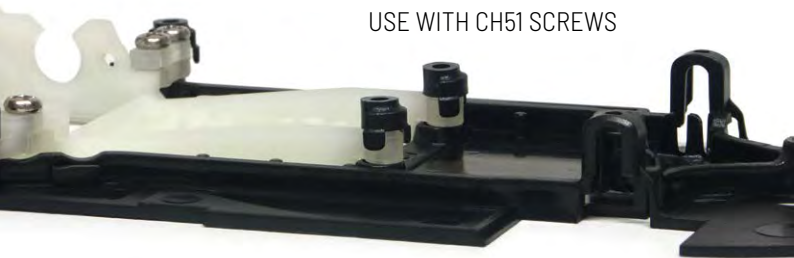

Cable/Braids/Terminals

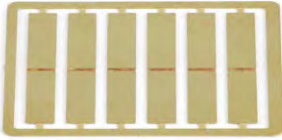

SP37
LMP pre-cut brass tabs
for pickup



SP22b
Silicon cable high flexibility
(1m)



10 SP29
LMP copper braid - (8x)



SP45
Cable with connectors
for motors - (3x)



SP04
Brass terminal
ø 1.5 L4 mm (10x)
motor cable and independent
front wheels axle



SP17
Brass terminals
ø 1.6 L5 mm (10x)



SP19
Copper braid (1m)



SP18
Tin plated copper braid (1m)

Pickups



CH66
Clip racing pickup rev. B
Standard Slot.it models



CH26
Clip racing pickup
Old standard Slot.it models



CH10
Screw universal Pickup



CH07
Screw pickup for wooden track



CH85
Screw racing pickup
for standard Slot.it models



CH17
Clip short shaft pickup

11



CH06
Clip long shaft pickup



CH85d
Advanced blade screw pickup

LMP Pickups



CH88b

LMP screw racing pickup rev. C Standard Slot.it LMP models



CH111

LMP screw racing pickup for 4WD system



CH112

LMP screw racing pickup for wooden track



CH84

LMP screw pickup for wooden track

fenster.com

fenster.com

DKR ENGINEERING

fenster.com

ACMA
B.R.M.
-Chronographes-

SKYLUX
Hello daylight!

24h
LE MANS

TE
Technologies

3

PRO / AM

P2

dataglobalTM

dataglobalTM

STIEFEL
Hydraulik • Pneumatik

STIEFEL
Hydraulik • Pneumatik

DKR ENGINEERING

FIA
ORCA

PAULY & PARTNER
KFZ.-Gechverstandigenburo

PAULY & PARTNER
KFZ.-Gechverstandigenburo

Motor configuration

Long inline



Endbell inline

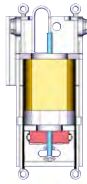

Can inline

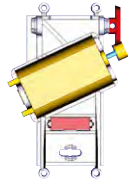
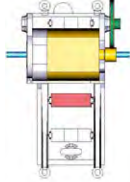
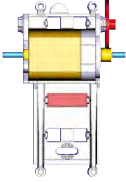
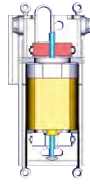

Old Sidewinder

Sidewinder

Anglewinder

14

The Slot.it motor mounts allow easy installation of short and long can type motors configured as inline, sidewinder, or anglewinder. The 'offset' concept enables upwards displacement of the rear shaft with regards to the bottom plane of the chassis and to the motor drive shaft, thus lowering the stance of the back of the car, to fine tune the ground clearance depending on type of track, wheels, tyres and motor, and desired model behaviour.

'Offset' is the vertical displacement, in mm, between the centres of the rear axle and of the motor shaft.

A further advantage of the 'Offset' principle is that the rear wheel can be properly positioned, vertically, inside the wheel arch of the bodywork.

In the '0.0' versions the motor shaft and the rear axle lie on the same plane, whereas in the 'offset' versions, unique to Slot.it, the rear axle is offset upwards, thus lowering the center of gravity of the car and increasing the magnetic traction which either the car magnet or the motor exert on the track.

Available offset motor mounts range from 0.0 to 1.25mm, depending on the selected motor mount type.

Another unique feature of the Slot.it motor mount are the self-aligning gimbals bushings. Traditional cylindrical bushings cannot compensate for chassis torsion and bad alignment;

Slot.it spherical bushing self adjust themselves to guarantee the minimum possible friction and can be made with optimal tolerances to eliminate excessive play.

Motor configuration

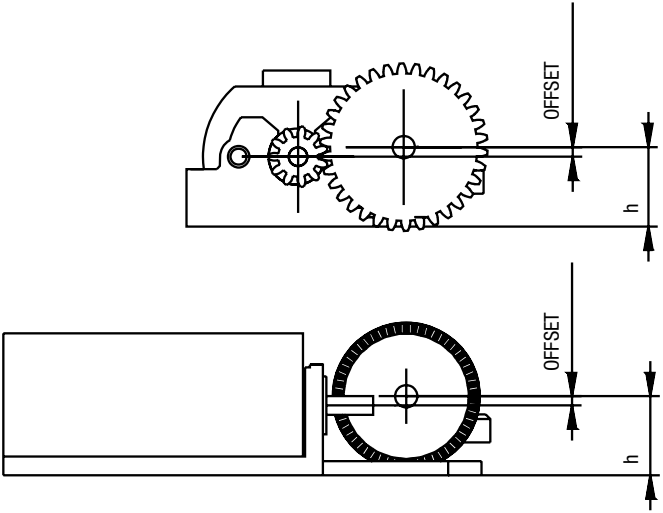

Offset Description

OFFSET (mm)	h (mm)	ITEMS		
0.0	7.5	CH13c CH48b CH34b	CH61 CH76 KK11 CH35	CH48b CH117c
0.5	8.0	CH31f CH33b CH60b1 CH60c	CH67 CH70 CH75 KK13b	CH109e CH110 CH114 CH118b
0.75	8.25	CH68	CH69	
1.0	8.5	CH24b CH32f CH49b CH65	CH74 CH82 KK10b KK12b KK14c	KK16b CH115b CH119b
1.25	8.75	CH123 CH124		

Motor mount

Anglewinder 0.0 Offset
for Boxer / Flat-6 motors



CH61 **Hard** - black
CH61c **Carbon fiber** - black

16



CH117c
Carbon fiber - black
To be used with CH105 bearing

**How to identify offset of
carbon fiber anglewinder
motor mounts - bearing version**

Look in the
direction of the
bearing seat and
check the dots

Motor mount

Anglewinder 0.5 Offset

for Boxer / Flat-6 motors



CH60b1 **Hard** - grey

CH60c **Carbon fiber** - black



CH118b **Hard** - grey

CH118c **Carbon fiber** - black

To be used with CH105 bearing

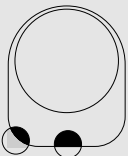

1.25mm
CH124

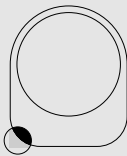

1.0mm
CH119c

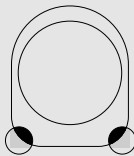

0.5mm
CH118c

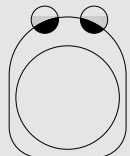

0.0mm
CH117c

Motor mount

Anglewinder 1.0 Offset

for Boxer / Flat-6 motors



CH74

Medium - no pigment

GT-LMP box stock models

18



CH82b **Hard** - no pigment

CH82c **Carbon fiber** - black

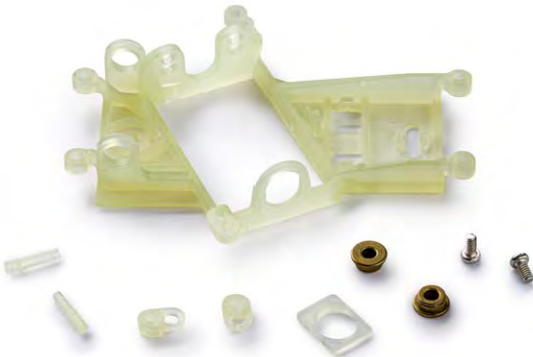

CH119b **Hard** - no pigment

CH119c **Carbon fiber** - black

To be used with CH105 bearing

Motor mount

Anglewinder 1.25 Offset

for Boxer / Flat-6 motors



CH123

Carbon fiber - black

CH130

Hard



CH124

Carbon fiber - black

CH131

Hard

To be used with CH105 bearing



Motor mount

Sidewinder 0.5 Offset
for V12 motor



CH67

Medium - grey

Classic box stock models

Motor mount

20 Sidewinder 0.75 Offset
for V12 motor



CH68

Medium - white - 4 fixing points



CH69

Medium - white - 6 fixing points

Motor mount

Sidewinder 1.0 Offset

for V12 motor



CH65

Medium - no pigment

GT3 box stock models



21

CH115b

Medium - no pigment

To be used with CH105 bearing



Motor mount

Inline 0.0 Offset

for V12 Motor



CH13c

Medium - black

Inline 0.5 Offset

for V12 Motor

22



CH110

Medium - grey

Classic DTM and Group C box stock models

Inline 1.0 Offset

for V12 Motor



CH24c

Medium - no pigment

Motor mount

Inline 0.0 Offset

for Boxer / Flat-6 Motors



CH48b

Hard - black

Inline 0.5 Offset

for Boxer / Flat-6 Motors



CH114

Hard - grey

Inline 1.0 Offset

for Boxer / Flat-6 Motors



CH49b

Hard - no pigment

Motor mounts

Conversion Kit OFFSET 0.0 mm



KK11

Anglewinder Conversion Kit

Z30 AW Crowns + Z11 Ø 6.5 mm Pinion

Conversion Kit OFFSET 0.5 mm

24



KK13b

Sidewinder Conversion Kit

Z34 Ø 18 SW Crowns + Z11 Ø 6.5 mm Pinion

Conversion Kit OFFSET 1.0 mm



KK12b

Sidewinder Offset Conversion Kit

Z34 Ø 18 SW Crowns + Z11 Ø 6.5mm Pinion

Motor mounts

Conversion Kit OFFSET 1.0 mm



KK10c
Anglewinder Conversion Kit
Z30 AW Crowns + Z11 Ø 6.5mm Pinion



KK14d
Flat Anglewinder Offset Conversion Kit
Z25 Ø15 AW plastic Crown + Z11 Ø 6.5mm Pinion



KK16b
Flat Anglewinder Offset PCR Conversion Kit
Z28 Ø15 AW plastic Crown + Z11 Ø 6.5mm Pinion



CH107
Z16 pulley
 for magnesium
 wheels



●
 CH99
Z16 pulley
 cyan - (2x)



● ●
 CH100
Z17 pulley
 black - (2x)



● ● ●
 CH101
Z18 pulley
 yellow - (2x)



PA73as
Assembled front plastic 4WD
 Ø16.5 x 8.2 wheels (2x)

26 PA72as
Assembled front plastic 4WD
 Ø15.8 x 8.2 wheels (2x)

PA74as
Assembled front plastic 4WD
 Ø17.3 x 8.2 wheels (2x)



PA73
Front plastic wheels
 Ø16.5 mm (2x)

PA72
Front plastic wheels
 Ø15.8 mm (2x)

PA74
Front plastic wheels
 Ø17.3 mm (2x)



CH95
Hubs for 4WD
 front wheels (2x)



CH96
Bearings for 4WD
 front wheels (2x)

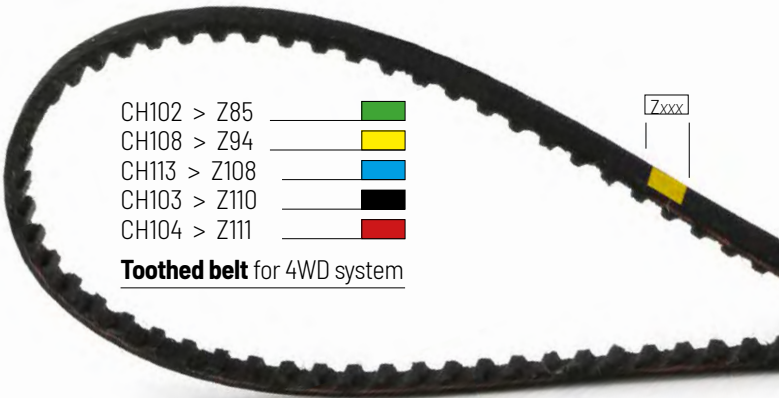

- CH102 > Z85
- CH108 > Z94
- CH113 > Z108
- CH103 > Z110
- CH104 > Z111

Zxxx

Toothed belt for 4WD system



CH98y
Tensioner, flanges and spacers
 yellow

27

CH98
Tensioner, flanges and spacers

CH98c
Tensioner, flanges and spacers
 cyan



CH97
Snap rings
 for 4WD front wheels (10x)



CH94
0.08mm spacers
 for 4WD wheels (6x)

Motors

Slot.it motors are available in three different configurations:

the traditional 'small can' **V12/4** type, the longer '**Boxer**' type, and Slot.it's own '**Flat-6**'.



INLINE

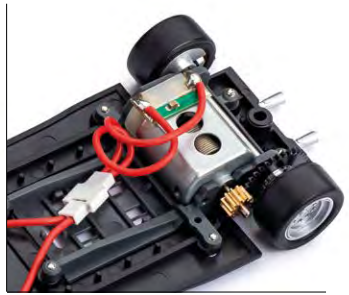

SIDEWINDER

'**Inline**' refers to the motor axle being perpendicular to the rear axle.

'**Sidewinder**' indicates that the motor runs parallel to the rear axle, i.e., transversely.

28

'**Anglewinder**' is a combination of the above configurations.



ANGLEWINDER



INLINE BOXER

The **FLAT-6** is a custom-built Slot.it motor designed to be compatible with existing Boxer/NC type motor pods while also taking advantage of a lower center of gravity when used in special Slot.it motor pods. Its 'slim' form allows for use in anglewinder configuration under streamlined LMP racers like Slot.it's **Audi R8C**, **Lola LMP**, and **Audi R18 TDI**.

Motors

The **V12/4** motors feature a double axle, making them a universal motor upgrade for cars from most manufacturers. Additionally, a special 'RX' adapter is available to upgrade cars with an 'RX' motor to a V12 one.

The '**Boxer**' type motors are ideal upgrades for the larger motors found in some slot cars. They can also be used as inline or 'anglewinder'.



Boxer motor mount



Flat motor mount

29

All 'small can' motors MX16, MX17, and their variants have the RPM value laser engraved on the side of the metal case, e.g., 21K or 23K.



Motors Flat-6



The Flat-6 is a Slot.it proprietary design

MN09CH

Flat-6 Classic GT / LMP

Slot.it models box stock
20.500 rpm - 200g*cm @12V



30



MN13CH

Flat-6S

22.500 rpm - 230g*cm @12V



GT RACING

MN14H

Flat-6RS

25.000 rpm - 240g*cm @12V - asymmetric case openings



MN11H-2

Flat-6R

22.000 rpm - 220g*cm @12V



High magnetic traction

Motors Boxer



The Boxer/2 is the most powerful Slot.it motor.



MN08CH

Boxer/2

21.500 rpm - 340g*cm @12V

Motors V12/4

MX15

V12/4 Classic DTM / Touring Cars

Slot.it models box stock

21.000 rpm - 150g*cm @12V

MX16

V12/4 Gr.C/Classic

Slot.it models box stock

23.000 rpm - 170g*cm @12V

MX17

V12/4

29.000 rpm - 160g*cm @12V



31



MX16-M

V12/4 Classic / Modern GT

Slot.it models box stock

23.000 rpm - 170g*cm @12V

SP08

Adaptor V12 to RX shape motor



Pinions

∅ 5.5 mm - Brass



Pinion 8 teeth (2x) _____ PI08

Pinion 9 teeth (2x) _____ PI09

Pinion 10 teeth (2x) _____ PI10

Pinion 11 teeth (2x) _____ PI11

Pinion 8+9+10+11 teeth (4x) _____ PIMX

32

∅ 6 mm - Brass



Pinion 10 teeth (2x) _____ PI6010o

Pinion 11 teeth (2x) _____ PI6011o

∅ 6.75 mm - Brass



Pinion 11 teeth (2x) _____ PI6711o

Pinion 12 teeth (2x) _____ PI6712o

Pinions

Ø 6.5 mm - Brass



Pinion 10 teeth (2x) _____ PS10

Pinion 11 teeth (2x) _____ PS11

Pinion 12 teeth (2x) _____ PS12

Pinion 13 teeth (2x) _____ PS13

Pinion 10+11+12+13 teeth (4x) _____ PSMX

Ø 6.5 mm - Ergal

33



Pinion 10 teeth (1x) _____ PI6510e

Pinion 11 teeth (1x) _____ PI6511e

Pinion 12 teeth (1x) _____ PI6512e

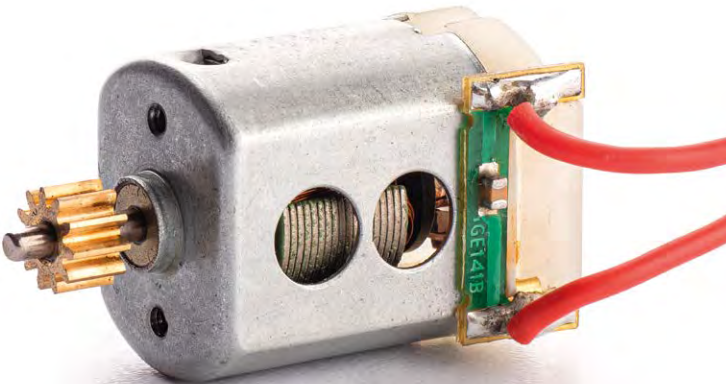

Pinions

Ø 7 mm - Ergal



Pinion 12 teeth (1x)	_____	PI7012e
Pinion 13 teeth (1x)	_____	PI7013e
Pinion 14 teeth (1x)	_____	PI7014e

Probably the best pinion in the world:
0.3 grams only, chemically hardened and Teflon coated

34

Ø 5.5 mm - Internal Ø 1.5mm



Pinion 9 teeth (2x)	_____	PI559o15
Pinion 10 teeth (2x)	_____	PI5510o15

Ø 6 mm - Internal Ø 1.5mm



Pinion 10 teeth (2x)	_____	PI6010o15
-----------------------------	-------	-----------

Extractor / Press

The SLOT.IT extractor/press consists of the following components:

Main frame: **[1]** constructed entirely from fiberglass-reinforced plastic. The main screw passes through two co-molded brass threads to prevent wear on the thread itself. The dimensions of the plastic body are designed to accommodate most motors, from common short can motors to less common double long transmission shaft 4WD motors. Counter bushing **[6]**: Made of brass, this bushing must be screwed onto the lower inside part of the main body before using the tool. The counter bushing serves two important functions:

- Centres the double shaft motor perfectly using the axle housing hole.
- Keeps all motors that do not have a double shaft centred and protects the inner bushing of long can motors that do not have an axle stub protruding from the can.

Special steel extraction plate **[5]**: Fits into the relevant housing in the main body to extract the pinions. This plate is highly resistant and features a very thin eyelet located between the motor and the pinion, measuring only 0.7 mm. This allows for the extraction of pinions located very close to the motor case without causing damage. Multifunction brass tool **[2]**: Depending on the operation to be performed, this tool must be inserted into the main body with the plug (steel, interchangeable, Ø1.9mm to avoid damaging the pinion hole) downwards for extraction, or the pinion housing downwards for pressing. The pinion housing for this element is designed to accommodate pinions with a diameter ranging from 5.5mm to 7.5mm without damaging them.

Steel plug **[3]**: Locked into the brass tool by an M3 grub screw **[4]**.

Advancement screw **[7]**: The upper part of this screw features an ergonomic plastic knob **[8]**, while the lower part is designed to couple perfectly with the tool bevel, reduce friction, and allow the press to operate perpendicularly without clearance.



TL01

Professional Extractor Press

Extractor / Press

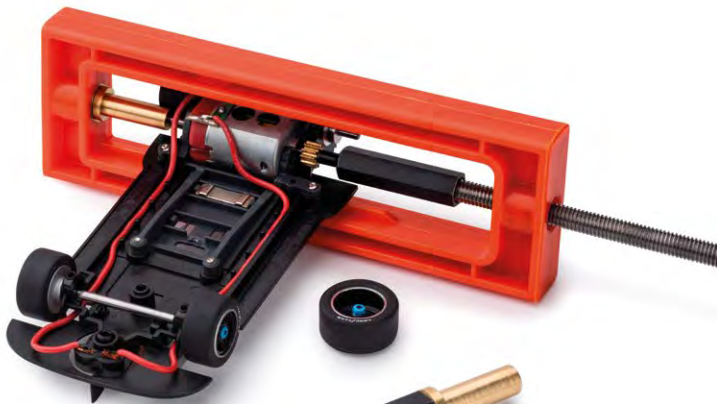

PRESS THE PINION
LEAVING MOTOR AND
CROWN IN PLACE



TL04

Professional upgrade kit
for extractor press TL01/SP21

36



TL06b

Professional extractor press and puller set



TL02

Extraction plate and counter
plate spares for TL01/SP21



TL03

Multifunction brass tool steel
plug and M3 screw for SP21/TL01

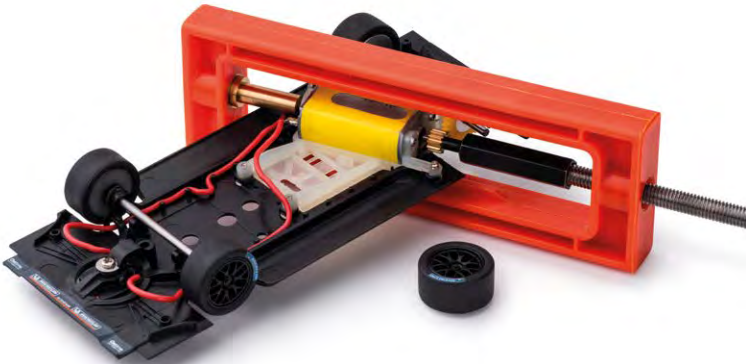

PULL THE PINION
LEAVING MOTOR
AND CROWN
IN PLACE

37



TL05b

Professional Mini Puller

now for up to 7.5mm diameter pinions

TL08

Steel plug

ø 1.9 and ø 1.4mm for extractor
SP21/SP31b/TL01/TL05/TL06 (1+1)



TL01

Professional extractor press and puller set

Sidewinder Spur Gears

M2 HEX

SCREW

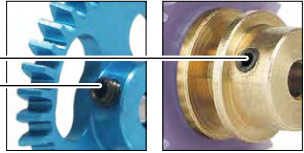

Ergal light Ø18 mm

31 teeth silver color	_____	GS1831
32 teeth black color	_____	GS1832
33 teeth pink color	_____	GS1833
34 teeth cyano color	_____	GS1834
35 teeth gold color	_____	GS1835
36 teeth violet color	_____	GS1836

38



Aluminium + light plastic Ø18 mm

31 teeth white color	_____	GS1831-LPL
32 teeth black color	_____	GS1832-LPL
33 teeth pink color	_____	GS1833-LPL
34 teeth cyano color	_____	GS1834-LPL
35 teeth yellow color	_____	GS1835-LPL
36 teeth violet color	_____	GS1836-LPL

Sidewinder Spur Gears



Ergal light Ø19 mm

34 teeth cyano color	_____	GS1934
36 teeth violet color	_____	GS1936
38 teeth green color	_____	GS1938

Inline Offset Modular Crowns



39

Aluminium

23 teeth Ø13,8 mm plastic external diameter	_____	GM23o
24 teeth Ø14,4 mm plastic external diameter	_____	GM24o
25 teeth Ø14,8 mm plastic external diameter	_____	GM25o
26 teeth Ø15,3 mm plastic external diameter	_____	GM26o
27 teeth Ø15,8 mm plastic external diameter	_____	GM27o
28 teeth Ø16,3 mm plastic external diameter	_____	GM28o
29 teeth Ø16,8 mm plastic external diameter	_____	GM29o
30 teeth Ø17,3 mm plastic external diameter	_____	GM30o

Inline Modular Crowns



Aluminium

40

23 teeth pink color	_____	GM23i
24 teeth green color	_____	GM24i
25 teeth orange color	_____	GM25i
26 teeth blue color	_____	GM26i
27 teeth black color	_____	GM27i
28 teeth yellow color	_____	GM28i
29 teeth violet color	_____	GM29i
30 teeth red color	_____	GM30i

Modular Crowns



Ferrule for Ø5,5mm pinions	_____	GMF55
Ferrule for Ø6mm pinions	_____	GMF60

Inline Crown Gears



41

Bronze / Aluminium + teflon

23 teeth pink color	_____	GI23-bz / GI23-al
24 teeth green color	_____	GI24-bz / GI24-al
25 teeth orange color	_____	GI25-bz / GI25-al
26 teeth blue color	_____	GI26-bz / GI26-al
27 teeth black color	_____	GI27-bz / GI27-al
28 teeth yellow color	_____	GI28-bz / GI28-al
29 teeth violet color	_____	GI29-bz / GI29-al
30 teeth red color	_____	GI30-bz / GI30-al

Set 24-26-27-28-30 teeth - Bronze insert

GIX1

Inline Offset Crown Gears



42

Bronze / Aluminium + teflon

- 23 teeth** Ø13,8 mm plastic external diameter — G023-bz / G023-al
- 24 teeth** Ø14,4 mm plastic external diameter — G024-bz / G024-al
- 25 teeth** Ø14,8 mm plastic external diameter — G025-bz / G025-al
- 26 teeth** Ø15,3 mm plastic external diameter — G026-bz / G026-al
- 27 teeth** Ø15,8 mm plastic external diameter — G027-bz / G027-al
- 28 teeth** Ø16,3 mm plastic external diameter — G028-bz / G028-al
- 29 teeth** Ø16,8 mm plastic external diameter — G029-bz / G029-al
- 30 teeth** Ø17,3 mm plastic external diameter — G030-bz / G030-al

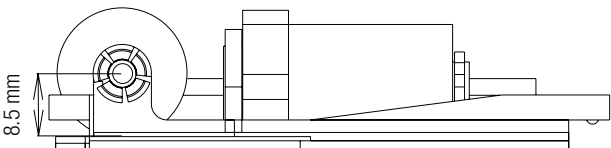

FOR OFFSET MOTOR MOUNT CH24c - CH49b

Anglewinder Gears

Ergal Anglewinder Gears



Ergal light Ø16 mm

26 teeth cyano color	_____	GA1626e
27 teeth black color	_____	GA1627e
28 teeth gold color	_____	GA1628e
29 teeth violet color	_____	GA1629e
30 teeth red color	_____	GA1630e
31 teeth silver color	_____	GA1631e

43



Ergal light Ø18 mm

32 teeth black color	_____	GA1832e
33 teeth pink color	_____	GA1833e
34 teeth cyano color	_____	GA1834e
35 teeth gold color	_____	GA1835e
36 teeth violet color	_____	GA1836e

Anglewinder Gears

Ø15mm Plastic Anglewinder Gears

REQUIRES Ø 6.75 mm PINIONS



Aluminium - for Flat motors

24 teeth green color	_____	GA1524-PI
25 teeth orange color	_____	GA1525-PI
26 teeth blue color	_____	GA1526-PI

44

Anglewinder Gears

Ø16mm Plastic Anglewinder Gears



Aluminium

26 teeth blue color	_____	GA1626-LPL
27 teeth black color	_____	GA1627-LPL
28 teeth yellow color	_____	GA1628-LPL
29 teeth violet color	_____	GA1629-LPL
30 teeth red color	_____	GA1630-LPL

AVAILABLE GEAR RATIOS

Pinions			Inline crowns										Sidewinder Ø18mm spur gears					Sidewinder Ø19mm spur gears			Anglewinder Ø15mm gears					Anglewinder Ø16mm gears					Anglewinder long hub gears									
Ø5.5 mm	Ø6.5 mm	Ø6 mm	Ø6.75 mm	Ø7 mm	23	24	25	26	27	28	29	30	31	32	33	34	35	36	34	36	38	24	25	26	26	26	27	28	29	30	31	32	33	34	35	36	24	26		
8					2.88	3.00	3.13	3.25	3.38	3.50	3.63	3.75							4.25	4.50	4.75																			
9					2.56	2.67	2.78	2.89	3.00	3.11	3.22	3.33							3.78	4.00	4.22																			
10	10	10			2.30	2.40	2.50	2.60	2.70	2.80	2.90	3.00	3.10	3.20	3.30	3.40	3.50	3.60	3.40	3.60	3.80				2.60	2.70	2.80	2.90	3.00	3.10	3.20	3.30	3.40	3.50	3.60					
11	11	11	11		2.09	2.18	2.27	2.36	2.45	2.55	2.64	2.73	2.82	2.91	3.00	3.09	3.18	3.27	3.09	3.27	3.45			2.36	2.45	2.55	2.64	2.73	2.82	2.91	3.00	3.09	3.18	3.27	3.09	3.18	3.27	2.18	2.36	
	12	12	12	12									2.58	2.67	2.75	2.83	2.92	3.00	2.83	3.00	3.17	2.00	2.08	2.17	2.17	2.25	2.33	2.42	2.50	2.58	2.67	2.75	2.83	2.92	3.00	2.00	2.00	2.00	2.00	2.17
	13	13	13	13									2.38	2.46	2.54	2.62	2.69	2.77	2.62	2.77	2.92	1.85	1.92	2.00	2.00	2.08	2.15	2.23	2.31	2.38	2.46	2.54	2.62	2.69	2.77					
				14																		1.71	1.79	1.86																

Inline crown

Offset crown

18mm spur gear

19mm spur gear

Anglewinder Ø16 gears

Anglewinder long hub gears

Anglewinder Ø15 gears

Anglewinder Ø15 gears

GI23/24/25/26/27/28/29/30 require CH13c/CH48b motor mount and brass 5.5mm pinions **P108/09/10/11**

GO23/24/25/26/27/28/29/30 require CH24c/CH49b offset motor mounts and brass 5.5mm pinions **P108/09/10/11**

GS1831/32/33/34/35/36 require CH67/CH68/CH69 motor mounts and brass 6.5mm pinions **PS10/11/12/13** or Ergal 6.5mm pinions **PI6510E/6511E/6512E/6513E**

GS1934/36/38 require CH65/CH67/CH68/CH69/CH115 motor mount and 6mm pinions **PI60110/60120**.

GA34/36 and GA1626E/1627E/1628E/1630E/1631E/1632E/1633E/1634E/1635E require CH61/CH60b/CH74/CH75/CH76/CH82/CH117/CH118/CH119 motor mounts and brass 6.5mm pinions **PS10/11/12/13** or Ergal 6.5mm pinions **PI6510E/6511E/6512E/6513E**.

GA1626-P/1627-P/1628-P/1629-P/1630-P/1631-P require brass 6mm pinions **PI60110/60120** and 0.75mm spacer **PA52**. Otherwise require brass 6.5mm pinions **PS10/11/12/13** or Ergal 6.5mm pinions **PI6510E/6511E/6512E/6513E**.

GA24LH/26LH require CH61/CH60b/CH74/CH75/CH76/CH82/CH117/CH118/CH119 motor mounts and brass 6.75mm pinions **P67110/67120**.

GA1524-P/1525-P/1526-P/1526-PI require brass 6.5mm pinions **PS10/11/12/13** and 1mm spacer **PA51** or Ergal 6.5mm pinions **PI6510E/6511E/6512E/6513E** and 1mm spacer **PA51**.

GA1524-P/1525-P/1526-P/1526-PI require Ergal 7mm pinions **PI7012E/7013E/7014E** without spacers

Starter Kit

KK01b

Kit inline

Z28 crown

15.8x8.2x1.5mm wheels

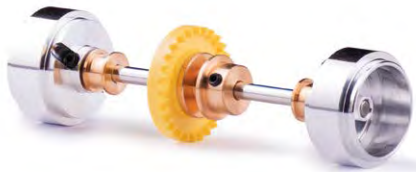

KK07c

Kit inline

Z28 crown

17.3x9.75x1.5mm wheels

+ 1mm spacers



46

KK08b

Kit inline

Z27 crown

15.8x8.2x2.5mm plastic wheels



OLD CARRERA

KK03c

Kit inline

Z26 crown + Z9 pinion

17.3x9.75x1.5mm wheels

+ 1mm spacers



CARRERA DTM

KK17

Kit inline

Z26 crown

17.3x8.2mm wheels



Starter Kit

KK02b

Kit sidewinder

Z36 Ø19 crown

15.8x8.2x1.5mm wheels

+ 1mm spacers



KK04c

Kit sidewinder

Z36 Ø19 crown

17.3x9.75x1.5mm wheels

+ 1mm spacers



KK05b

Kit sidewinder

Z34 Ø18 crown

15.8x8.2x1.5mm wheels

+ 1mm spacers

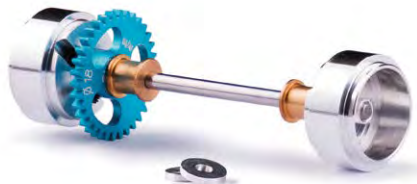

KK15b

Kit sidewinder

Z36 Ø19 crown

17.3x8.2x1.5mm wheels

+ 1mm spacers



47

KK09d

Kit anglewinder

Z32 crown + Z12 pinion

17.3x9.75x1.5mm wheels



KK18

Upgrade kit

for vintage

Policar cars



Wheels

∅ 14.3 x 8 mm

W14308015A ex PA33-Als

Al ∅14.3 x 8 x 1.5mm

wheels, M2 grub - 1.2g (2x)



W14308015P ex WH1215-PI

PI ∅14.3 x 8 x 1.5mm

wheels, 0.59g (4x)



∅ 15.8 x 8.2 mm

W15808225A ex WH1050-Al

Al ∅15.8 x 8.2 x 2.5mm

wheels, M2 grub - 1.4g (2x)



48

W15808215A ex PA24-Als

Al ∅15.8 x 8.2 x 1.5mm

wheels, M2 grub - 1.4g (2x)



W15808215Ma ex WH1183-Mg

Mg ∅15.8 x 8.2 x 1.5mm

hollow wheels, M2 grub, 0.8g (2x)



W15808215AF ex PA24-Alf

Al ∅15.8 x 8.2 x 1.5mm

wheels double shoulder

M2 grub - 1.1g (2x)



W15808225M ex PA17-Mg

Mg ∅15.8x8.2x2.5mm

wheels, M2 grub - 0.9g (2x)



W15808215AH ex PA24-Alh

Al ∅15.8 x 8.2 x 1.5mm

wheels double shoulder

holed channel M2 grub - 1g (2x)



Wheels

ø 15.8 x 8.2 mm

W15808225P ex PA17-PI

PI Ø15.8x8.2x2.5mm

wheels 0.71g (4x)



W15808215P ex WH1210-PI

PI Ø15.8x8.2x1.5mm

wheels 0.7g (4x)



W15808205P

PI Ø15.8x8.2x0.5mm

wheels 0.7g (4x)



W15808215-3D

3D Ø15.8x8.2x1.5mm

wheels, (2x)



49

ø 15.8 x 10.2 mm

W15810215AF ex PA49-Alf

Al Ø15.8 x 10.2 x 1.5mm

wheels, double shoulder,
M2 grub - 1.3g (2x)



W15810215AH ex PA49-Alh

Al Ø15.8 x 10.2 x 1.5mm

wheels, double shoulder
holed channel, M2 grub - 1.2g (2x)



W15810215M ex WH1184-Mg

Mg Ø15.8 x 10.2 x 1.5mm

hollow wheels, M2 grub, 0.9g (2x)



Wheels

Ø 16.5 x 8.2 mm

W16508215A ex PA43-Als
Al Ø16.5 x 8.2 x 1.5mm
wheels, M2 grub, 1.5g (2x)



W16508215Ma ex WH1185-Mg
Mg Ø16.5 x 8.2 x 1.5mm
hollow wheels, M2 grub, 0.75g (2x)



W16508215-3D
3D Ø16.5x8.2x1.5mm
wheels, (2x)



W16508225P ex PA43-PI
PI Ø16.5 x 8.2 x 2.5mm
wheels, 0.76g - (4x)



50

Ø 16.5 x 10.2 mm

W16510215M ex WH1186-Mg
Mg Ø16.5 x 10.2 x 1.5mm
hollow wheels, M2 grub, 0.9g (2x)



Ø 16.9 x 8.2 mm

W16908215M ex WH1288-Mg
Mg Ø16.9 x 8.2 x 1.5mm
hollow wheels, M2 grub, 0.78g (2x)



Ø 16.9 x 9.75 mm

W16909715Ma
PI Ø16.9 x 9.75 x 1.5mm
hollow wheels,
M2 grub, 0.85g (2x)



Ø 17.3 x 8.2 mm

W17308225A ex WH1048-Al
Al Ø17.3 x 8.2 x 2.5mm
wheels, M2 grub, 1.6g (2x)



Wheels

Ø 17.3 x 8.2 mm

W17308215A ex WH1110-Al

Al Ø17.3 x 8.2 x 1.5mm

wheels, M2 grub, 1.6g (2x)



W17308215M ex WH1230-Mg

Mg Ø17.3 x 8.2 x 1.5mm

hollow wheels, M2 grub, 0.8g (2x)



W17308205P ex WH1254-PI

PI Ø17.3 x 8.2 x 0.5mm

wheels, 0.75g (4x)



W17308215P

PI Ø17.3 x 8.2 x 1.5mm

wheels, 0.72g (4x)



W17308225P ex WH1071-PI

PI Ø17.3 x 8.2 x 2.5mm

wheels, 0.8g (4x)



W17308215-3D

3D Ø17.3x8.2x1.5mm

wheels, (2x)



Ø 17.3 x 9.75 mm

W17309715A ex PA62-Als

Al Ø17.3 x 9.75 x 1.5mm

wheels, M2 grub, 1.6g (2x)



W17309715Ma ex WH1231-Al

Mg Ø17.3x9.75x1.5mm

hollow wheels, M2 grub, 0.9g (2x)



Wheels

Ø 17.3 x 10 mm

W17310005P ex WH1179-PI

PI Ø17.3 x 10 x 0.5mm

wheels, 0.85g (4x)



For Sponge Tyres

Compatible with Slot.it wheel inserts

W13609515A ex WH1211-AI

Ø13.6 x 9.5 x 1.5mm

wheels equivalent Ø15.8mm

M2 grub (2x)



52

W14209515A ex WH1190-AI

Ø14.2 x 9.5 x 1.5mm

wheels equivalent Ø16.5mm

M2 grub (2x)



W15009515A ex WH1212-AI

Ø15.0 x 9.5 x 1.5mm

wheels equivalent Ø17.3mm

M2 grub (2x)



PT1209SP25

SP25 compound

Sponge tyres

dwg 1209 (4x)

PT1209SP30

SP30 compound

Sponge tyres

dwg 1209 (4x)



Axle and Spacer

PA01-45
PA01-48
PA01-51
PA01-54



Steel ProAxle turned ground, polished - 2.38 mm (3/32") (2x)

PA01-51H
PA01-54H
PA01-58H



Steel ProAxle turned ground, polished, hollow - 2.38 mm (3/32") (2x)

PA01-48R
PA01-51R
PA01-54R

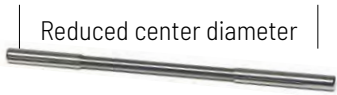

Steel ProAxle polished - 2.38 mm (3/32") for sidewinder (2x)

PA39
Independent front wheels axle



53

PA57



Light Stopper for anglewinder setup Aluminium (2x)

PA25



Stopper for anglewinder setup Aluminium+teflon (1x)

PA51

Set of spacers
for hubs 1mm thick (x10)



PA52

Set of spacers
for hubs and bushings
0.6mm thick

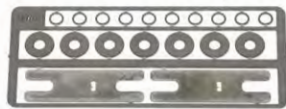

PA47

Set of spacers
for hubs and bushings
0.1 / 0.25mm thick



Plastic inserts

(for Ø15.8mm and for Ø16.5mm wheels)



PA55

Plastic inserts BBS '80s

for Ø15.8mm (4x) Ø16.5mm (2x) wheels - Porsche 956/962 type



PA53

Plastic inserts

for Ø15.8mm (4x) Ø16.5mm (2x) wheels Lancia LC2-85 type



PA48

Plastic inserts

for Ø15.8mm (4x) Ø16.5mm (2x) wheels Toyota 88C type



PA65

Plastic inserts

for Ø15.8mm (2x) Ø16.5mm (2x) wheels Nissan R89C type



PA44

Plastic inserts

for Ø15.8mm wheels (4x) - Mazda 787B type



PA30

Plastic inserts

for Ø15.8mm wheels (4x) - Sauber C9 type

Plastic inserts

(for Ø15.8mm and for Ø16.5mm wheels)



PA31

Plastic inserts

for Ø15.8mm wheels (4x) - Jaguar XJR type



PA34

Plastic inserts

for Ø15.8mm wheels (4x) - Lancia LC2-84 type



PA86

Plastic inserts

for Ø15.8mm wheels (4x) - Datsun 510 type

Plastic inserts

Modern GT/LMP

(for Ø17.3mm wheels)

PA60

Plastic inserts BBS

for Ø17.3mm wheels (4x)

Porsche 911 GT1 - Lola B09 B10 B11 - Aston Martin type



PA79

Plastic inserts OZ

for Ø17.3mm wheels (4x) - Maserati GT3



PA70

Plastic inserts OZ

for Ø17.3mm wheels (4x) - 11 spokes



56

PA82

Plastic inserts RAYS

for Ø17.3mm wheels - Nissan GT-R Nismo GT3



PA84

Plastic inserts

for Ø17.3mm wheels (4x)



PA85

Plastic inserts

for Ø17.3mm wheels (4x)



Plastic inserts

Classic '70s

(for Ø14.3mm and for Ø15.8mm wheels)

PA63p

Plastic inserts

for Ø15.8mm wheels (4x) - McLaren M8D type



PA64

Plastic inserts

for Ø15.8mm wheels (4x)

Matra-Simca MS670B type



PA41

Plastic inserts

for Ø15.8mm (4x) Ø14.3mm (2x) wheels Alfa Romeo 33/3 type



PA45

Plastic inserts

for Ø15.8mm wheels (4x) - Chaparral 2E type



PA46

Plastic inserts

for Ø15.8mm wheels - (4+4) - Ford GT40 type



PA83

Plastic inserts

for Ø15.8mm wheels (4x) - 512M

57

Plastic inserts

Classic '70s

(for Ø14.3mm and for Ø15.8mm wheels)



PA86

Plastic inserts OZ

for Ø15.8mm wheels (4x) - Datsun 510

Classic DTM (for Ø15.8mm wheels)

58



PA71

Plastic inserts Speedline

for Ø15.8mm wheels (4+2)



PA75

Plastic inserts OZ

for Ø15.8mm wheels (4+2)



PA77

Plastic inserts BBS type

for Ø15.8mm wheels (4+2)

Plastic inserts

Classic DTM (for Ø15.8mm wheels)



PA78

Plastic inserts OZ

for Ø15.8mm wheels (4+2)



PA80

Plastic inserts

RAYS type 5 spoke for Ø15.8/16.5mm wheels



PA81

Plastic inserts

RAYS type 6 spoke for Ø15.8/16.5mm wheels

59

Modern GT/LMP

(for Ø15.8mm wheels)



- **black** Plastic inserts BBS for Ø15.8mm wheels _____ PA03b
 - **silver** Plastic inserts BBS for Ø15.8mm wheels _____ PA03s
 - **gold** Plastic inserts BBS for Ø15.8mm wheels _____ PA03g
-

Wheel inserts type may be different

Tyres



Low profile
front tyre



High grip
rear tyre



Realistic thread
rear tyre



F1
rear tyre

PT19 > **Z1** - 8x14.2 (4x)
dwg 1096 - Low profile slick

PT1214S2 > **S2** - 8.4x14.6 (4x)
dwg 1214 - Low profile slick

PT1088C1 > **C1**
dwg 1088 - slick 8x16.1(4x)

PT1159C1 > **C1**
dwg 1159 - slick 9.5x17.2 (4x)

PT1228C1 > **C1**
dwg 1228 - slick 9.5x17.8 (4x)

PT1140C1 > **C1**
dwg 1140 - slick 9.5x19.8 (4x)

PT15 > **Z0** - 10x16.5 (4x)
dwg 1067 - Low profile slick

PT1167C1 > **C1** PT1167S2 > **S2**
dwg 1167 - slick 10x17.8 (4x)

PT1207P6B > **P6B** PT1207G25 > **G25**
PT1207F22 > **F22** dwg 1207 - slick 10x18 (4x)

PT1323C1 > **C1** PT1323G25 > **G25** PT1323F22 > **F22**
dwg 1323 - slick 10.6x20.2 (4x)

DIMENSION OF TYRE AFTER ASSEMBLY ON WHEEL

REFERENCE BY TRACK - COMPOUND - TYRES CODE

Suggested use >	Ninco	Carrera	Front wheels only			Policar		
Compound >	P5	P6	Z0	Z1	S2	G25	F22	P6B
Reference Code >	PT23	PT25	PT07 PT15	PT19	PT1214S2	PT1207G25 PT1171G25 PT1172G25 PT1323G25	PT29 PT1171F22 PT1207F22 PT1323F22 PT1172F22	PT1207SP6B PT1027SP6B PT1028SP6B

■ = box stock

REFERENCE BY WHEELS DIMENSION - TYRES CODE/DWG

WHEELS								
dim.(mm)	PT19	PT1214S2	PT1088C1	PT1159C1	PT1228C1	PT1140C1	PT15	PT1167C1 PT1167S2
14.3	15.1	15.1	17	x	x	x	x	x
15.8	16.7	16.7	18.4	18.3	19.8	20.1	17	19.1
16.5	17.3	17.3	19	18.9	20.3	20.6	17.6	19.6
16.9	17.6	17.6	19.3	19.2	20.6	20.9	17.9	19.9
17.3	18.1	18.1	19.7	19.4	21	21.3	18.3	20.3
dwg	1096	1214	1088	1159	1228	1140	1067	1167
Tyres dimension (mm)	8 x 14.2	8.4 x 14.6	8 x 16.1	9.5 x 17.2	9.5 x 17.8	9.5 x 19.8	10 x 16.5	10 x 17.8

Slot.it provides a comprehensive range of tires for the racer and the scale modeler alike.



Sponge tyre

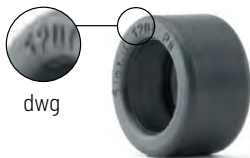

dwg

PT1027P6B > **P6B**
 PT06 > **S1** PT07 > **Z0**
 dwg 1027 - slick 10x18.8 (4x)

PT1171G25 > **G25** PT1171F22 > **F22**
 dwg 1171 - slick 10x19.5 (4x)

PT1121C1 > **C1**
 dwg 1121 - slick 10x19.5 (2x)
 PT1120C1 > **C1**
 dwg 1120 - slick 10.5x20 (2x)

PT1152C1 > **C1**
 dwg 1152 - slick 10.5x19 (4x)

PT1172G25 > **G25** PT1172F22 > **F22**
 dwg 1172 - slick 11.3x20 (4x)

PT1028P6B > **P6B** PT03 > **S1**
 dwg 1028 - 12.2x19.8 - (4x)

PT16 > **S1** PT23 > **P5** PT29 > **F22**
 dwg 1068 - F1 12.4x20.4 - (4x)

Any	Scalextric Sport	Smooth and clean surface	
SP30	C1	S1	S2
PT1209SP30	PT1152C1 PT1159C1 PT1167C1 PT1088C1 PT1228C1 PT1323C1 PT1140C1 PT1120C1 PT1121C1	PT03 PT06 PT16	PT1167S2

SPONGE TYRES	
Compound	SP30 / SP25
Code	PT1209SP30 / PT1209SP25
dwg	1209
Tyres dimension (mm)	9.5 x 19.5

WHEELS FOR SPONGE TIRES (9.5 mm)		
Code	Diameter	Equivalence
W13609515A	13.0	15.8
W14209515A	14.2	16.5
W15009515A	15.0	17.0

PT1207F22 PT1207N22 PT1207G25 PT1207P6B	PT1027P6B PT06 PT07	PT1171F22 PT1171G25	PT1121C1	PT1152C1	PT1120C1	PT1323F22 PT1323C1 PT1323G25	PT1172F22 PT1172G25	PT1028P6B PT25 PT03	PT16 PT23 PT29
x	x	x	x	x	x	x	x	x	x
19.6	19	19.7	19.4	19	19.9	20.2	19.9	19.7	x
20.2	19.6	20.3	20	19.6	20.5	21	20.4	20.3	x
20.5	19.9	20.6	20.3	19.9	20.8	21,3	20.7	20.6	x
20.8	20.2	21	20.7	20.3	21.2	21,4	21.1	21	x
1207	1027	1171	1121	1152	1120	1323	1172	1028	1068
10 x 18	10 x 18.8	10 x 19.5	10 x 19.5	10.5 x 19	10.5 x 20	10.6x20.2	11.3 x 20	12.2 x 19.8	12.4 x 20.4

Bushings & Pulleys

CH105

Flanged bearings for CH118 - CH119 - CH115 - CH117
and for Policar F1(2x)



CH14

Bronze spherical bushings (6x)



PA02

Bronze bushings (2x)



PA32

Aluminium bushings Aluminium+Teflon (2x)



PA12

Brass bushings old Carrera (2x)



PA11

Bronze bushings for Proslot (2x)



PA68

Brass bushings for Carrera and Scalextric (4x)



62

CH56b

Bronze spherical bushings
Standard Slot.it models (6x)



Magnet

CN01

Neodimium magnet 25x8x2mm for Scalextric



CN02

Neodimium C shaped magnet 25x8x2.3mm for Scalextric



CN06

Neodimium standard magnet for motor mounts



CN07

Neodimium race magnet for motor mounts



Ballast

SP23

Tungsten ballast motor
mount shape 2.5g (1x)



SP25

**Tungsten ballast
putty** 10g (1x)



SP24

Tungsten ballast cylinder
6.3x1mm, 0.58g (6x)



Suspensions



CH47c

Spring suspension kit - for all type of motor mounts

CH127

Fiberglass suspension bar
for CH47c (2x + 2x)



CH09

Magnetic suspension kit

CN08 - Ø 4x1mm (8x)

CN09 - Ø 4x1.5mm (8x)

CN10 - Ø6x1.5mm (8x)

CN12 - Ø6x1.5mm (8x) - increased magnetism

Neodimium magnet for magnetic suspension kit



CH77

Aluminium anodized end of run nuts (4x)



Spings For CH47c Suspension

CH55A

Soft springs (8x)

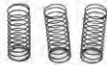

CH55B

Medium springs (8x)



CH55C

Ultra soft springs (8x)



CH55D

Short ultra soft springs (8x)



Screwdrivers



PA76

Adjustable torque hex
M2 screwdriver



PA67c

Adjustable torque Torx
T3 screwdriver



PA67b

Adjustable torque hex
M2.5 screwdriver



PA06

Hexagonal wrench
M2

Screws

64

PA58

Hexagonal screws
M2 x 2mm (10x)



PA40

Hexagonal screws
M2 x 3mm (10x)



PA37

Hexagonal screws
for front axle setup
M2 x 6mm (10x)



PA50

Hexagonal screws
M2 x 8mm (10x)



PA54

Hexagonal screws
M2 x 10mm (10x)



PA66

Torx screws
T3 x 3mm (10x)



CH54b

Metric screws
chamfered large head
2.2 x 5.3 mm (10x)



CH128

Pickup screws
with washer (5x)



CH89

Metric screws
brass M2.5x6mm
for Carrera (10x)



CH41c

Replacement motor
fixing screws (10x)



Screws



CH51

Metric screws 2.2 x 8mm small head (10x). Use for body or in conjunction with CH72



CH52

Metric screws 2.2x8mm big head (10x)



CH53

Metric screws 2.2x5.3mm small head (10x)



CH54

Metric screws 2.2x5.3mm big head (10x)



CH120

Body to chassis fixing screws (10x)



CH106

Set of screws for motor mount (8x)



CH121

M2 hexagonal nuts (10x)



CH122

Washers for M2 screws (20x)



CH125

Metric screws chamfered large head for suspensions L9 mm (10x)



CH126

Metric screws chamfered large head for suspensions L13 mm (10x)



CH129

Metric screws chamfered large head for suspension L11mm (10x)



CH90

Motor fixing screws M2 x 4 mm titanium (4x)

Cars spare parts

	MODEL	CODE	CHASSIS	SPARE PARTS
CLASSIC DTM / TOURING CARS	Alfa Romeo 155 V6 TI (1993/94)	CA35	CS35t-60	CS35p
	Alfa Romeo 155 V6 TI (1995)	CA40	CS40t-60	CS35p / CS40p
	Alfa Romeo 155 V6 TI (1994/95)	CA50	CS50t-60	CS35p / CS40p
	Alfa Romeo 155 V6 TI (1996)	CA45	CS45t-60	CS35p / CS40p
	Mercedes 190E	CA44	CS44t1	CS44p
	Opel Calibra V6	CA36	CS36t-60 / CS36t-60b	CS36p
	Nissan Skyline GT-R R32	CA47	CS47t	CS47p
	Merced C-Class (1994/95)	CA53	CS53t	CS53p
	Mercedes C-Class (1995/96)	CA54	CS54t	CS53p
	Datsun 510	CA59	CS59t	CS59p
GROUP C	Jaguar XJR12	CA13		CS07p
	Jaguar XJR6/9	CA07		CS07p
	Jaguar XJR10	CA42	CS42t-60	CS42p
	Jaguar XJR11	CA62	CS42t-60	CS62p
	Lancia LC2-84	CA08	CS08t-60b	CS08p
	Lancia LC2-85	CA21	CS08t-60b	CS21p
	Mazda 787B	CA15		CS15pp
	Mazda 767B	CA60	CS60t-60	CS60p
	Nissan R89C	CA28	CS28t-60	CS28p
	Porsche 956C KH	CA09	CS02t-60c*	CS02p3
	Porsche 956C LH	CA02	CS02t-60c	CS02p3
	Porsche 962 IMSA	CA25	CS03t-60d	CS02p3
	Porsche 962C	CA52	CS03t-60d	CS02p3
	Porsche 962C 85	CA34	CS03t-60d	CS02p3
	Porsche 962C KH	CA17	CS03t-60d	CS02p3
	Porsche 962C LH	CA03	CS03t-60d	CS02p3
	Sauber C9	CA06		
	Toyota 88C	CA19	CS19t-60c	CS19p
Toyota 86C	CA41	CS19t-60c	CS41p	

* from CA09e onwards

TRANSPARENT PARTS	COKPITS		WHITE KIT	BODY KIT
	POLYCARBONATE	PLASTIC		
CS35v / CS35vlx	CS35lx		CA35z	CS35b
CS35v / CS35vlx	CS35lx		CA40z	CS50b
CS35v / CS35vlx	CS35lx			CS50b
CS35v / CS35vlx	CS35lx		CA45z	
CS44v	CS44lx		CA44z1	CS44b1
CS36v	CS36lx		CA36z1	CS36b
CS47v	CS47lx		CA47z	CS47b
CS53v	CS53lx		CA53z	CS53b
CS53v	CS53lx		CA54z	CS53b
CS59v	CS59lx		CA59z	CS59b
CS07v	CS07il	CH87		CS13b
CS07v	CS07il	CH87		CS07b
CS42v	CS07il		CA42z	CS42b
CS42v	CS07il		CA62z	CA62b
CS08v	CS08il			
CS21v	CS08il		CA21z1	
	CS15lx			CS15b
CS60v	CS60lx		CA60z	CS60b
CS28v	CS28lx	CA28Z	CA28z	CS28b
CS02v1	CS02lx	CH81b	CA09z1	CS09b1
CS02v1	CS02lx	CH81b	CA02z1	CS02b1
CS02v1	CS02lx	CH81b	CA25z	
CS02v1	CS02lx	CH81b	CA52z	CS52b
CS02v1	CS02lx	CH81b	CA34z	CS34b
CS02v1	CS02lx	CH81b		CS17b1
CS02v1	CS02lx	CH81b	CA03z1	CS03b1
	CS05lx			
CS19v	CS19il	CH92	CA19z	CS19b
CS19v	CS19il	CH92	CA41z	

Cars spare parts

	MODEL	CODE	CHASSIS	SPARE PARTS
CLASSIC	Alfa Romeo Tipo 33/3	CA11	CS11t-60b	CS11p
	Chaparral 2E	CA16	CS16t-60	CS16p3 / CH71 / CH71lx
	Chaparral 2F	CA46	CS46t-60	CS46p / CH71 / CH71lx
	Ford GT40	CA18	CS18t-60b	CS18p
	Ford MKII	CA20	CS18t-60b	CS20p
	Matra MS 670 B (1973)	CA37	CS27t-60b	CS37p
	Matra MS 670 B (1974)	CA27	CS27t-60b	CS27p
	Matra MS 670 B short tail	CA57	CS57t-60	CS57p
	Matra MS 670 B long tail	CA67	CS57t-60	CS67p
	McLaren M8D	CA26	CS26t-60	CS26p
Ferrari 512M	CA51	CS51t-60	CS51p	
GT	McLaren F1 GTR	CA10		
	Nissan R390 GT1	CA04/05		CS04p
	Nissan R390 GT1 Long Tail	CA14		CS04p
	Porsche 911 GT1 EV098	CA23	CS23t-60	
LMP	Audi R18 e-tron quattro	CA29	CS24t-60c	CS29p
	Audi R18 TDI	CA24	CS24t2-60c CS24t2-60-3D	CS24p
	Audi R18 Ultra	CA38	CS24t-60c	CS24p / CS29p
	Audi R8 LMP 2000	CA33	CS33t-60b	CS33p
	Audi R8C	CA01	CS01t-2	CS01p
	Audi R8C Reloaded	CA12	CS12t-60	CS12p
	Lola Aston Martin DBR1-2	CA31	CS31t-60c CS31t2-60-3D	CS31p
	Lola B09/60, B10/60, B11/80, B12/69 EV	CA22	CS22t-60c CS22t1-60-3D CS22t2-60-3D	CS22p
	Oreca 07	CA55	CS55t-60 CS55t2-60-3D	CS55p CS55p-soft
	Acura ARX-05	CA56	CS55t-60	CS56p / CS56p-soft
Lola B12/80	CA39	CS22t-60c	CS22p	
MODERN GT	Maserati GT3	CA43	CS43t-60	CS43p
	Maserati GT4	CA48	CS48t	CS43p
	Nissan GT-R NISMO GT3	CA49a-b	CS49t-60	CS49p
	Nissan GT-R NISMO GT3	CA49d*	CS49t-60b	CS49p
	Audi R8 GT3	CA58	CS58t-60	CS58p

* and next models

TRANSPARENT PARTS	COKPITS		WHITE KIT	BODY KIT
	POLYCARBONATE	PLASTIC		
CS11v		CH58	CA11z1	CS11b1
CS16v		CH78	CA16z1	CS16b1
CS46v	CS46lx		CA46z	CS46b
CS18v	CS18lx		CA18z1	CS18b
CS20v	CS18lx		CA20z1	CS20b
CS37v			CA37z	CS37b
CS27v			CA27z	CS27b
CS57v			CA57z	CS57b
CS57v			CA67z	CA67b
CS26v			CA26z	CS26b
CS51v	CS51lx		CA51z	CS51b
	CS10il	CH86		
CS04v	CS04lx			CS14b
CS04v	CS04lx			CS14b
	CS23lx			
CS29v	CS24lx	CH91		CS29b
CS24v	CS24lx	CH91		CS24b1/ CS24b2
CS29v	CS24lx	CH91		
CS33v			CS33z1	CS33b
CS01v	CS12il			
CS12v	CS12il			
CS31v	CS22lx	CH93	CA31z1 / CA31z2	CS31b1 / CS31b2
CS22v	CS22lx	CH93		CS22b1 / CS22b2
CS55v	CS55lx CS55plx		CS55z	CS55b
CS56v	CS55lx / CS55plx		CS56z	CS56b
CS39v/CS22v	CS22lx	CH93	CA39z -CA39z1	CS39b1 / CS39b2
CS43v	CS43lx		CA43z	CS43b
CS43v	CS43lx			CS48b
CS49v	CS49lx		CA49z	
CS49v	CS49lx		CA49z1	CS49b
CS58v	CS58lx		CS58z	CS58b



Slot.it & Policar Official

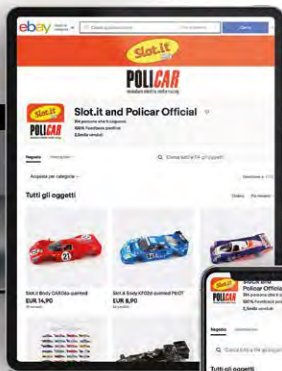
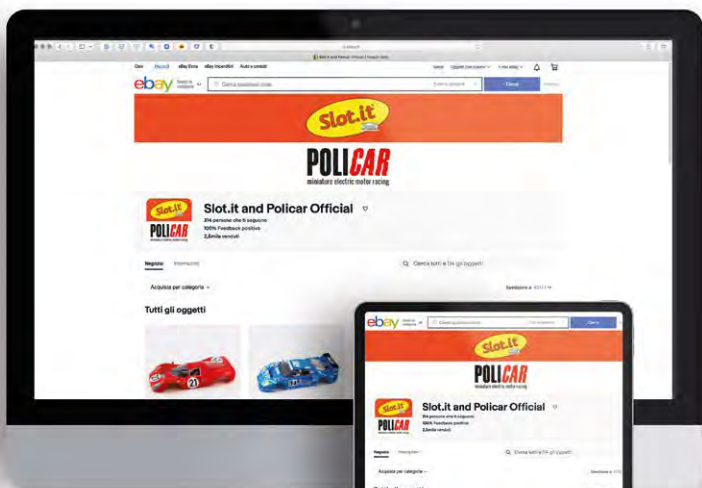

70



Add to cart

OXIGEN SLOT RACING DIGITAL SYSTEM

the right choice for the hobbyist

2.4GHz Wireless, supporting 20 cars per track, capable of accommodating up to 2 tracks within the same radio frequency range: oXigen, derived from the Catalan word for "oxygen," is the Slot.it digital slot racing system designed to handle up to 20 cars simultaneously on an unlimited number of lanes. oXigen boasts unparalleled features, range, and reliability honed over more than a decade of continuous refinement and innovation. Embraced by thousands of passionate racers worldwide, oXigen may be installed on circuits of all sizes, from carpet home setups to grand international 24-hour endurance races. Its versatility knows no bounds, seamlessly integrating with any track configuration. Additionally, oXigen-equipped cars can effortlessly transition to analog traditional tracks and even function as autonomous self-driving vehicles.

oXigen: just like analog

Ask any racer: driving an oXigen car feels just like driving a standard analog car. Why? **Because only the power comes from the rails, leaving the control signals to the 2.4GHz radio link.** Think about an RC car, powered from the slot track rails. No more 'delayed trigger' feeling so common on other systems! Additionally, oXigen does not require a dedicated power base, eliminating the need for extensive changes to the track power infrastructure.

Main features

- iOS and Android APP
- Chrono2 Racing Management System with full racing simulation
- Selective Lane Changing
- No dedicated power base, runs on standard analog tracks (with lane changers and finish line magnet markers)
- Compatible with SSD lane changers
- Native oXigen Policar lane changer



OXIGEN

SLOT.IT DIGITAL
Digital system

OXIGEN AND ARC READY



SCP301a

SCP3 Electronic Wireless Controller

integrated oXigen cartridge

72



O201c1

oXigen chip in-car controller



O201c-hr

Hall sensor

for O2 chip "C" type (1x)



O201c-S04

Bay lid for O201c chip,

Scalextric DPR
compatible hatch



CN11b - Neodymium magnet

25x8x4mm magnet (2x)



SCP301c
SCP3 power supply cartridge
for SCP3 controller



SCP301b
oXigen RF power amplifier
for SCP3 controller

73



0204b
oXigen dongle
supplied not active, you must
purchase the license with app



SP32
Spare IR LED on wires
for oXigen and SSD chips



0203b
oXigen lane changer driver
for Ninco/Carrera

Digital system

SCP-2



SCP201d1

SCP2 digital controller

for Carrera D132 and Scalextric SSD C7042

74



SCP201e1

Digital cartridge controller

for Carrera D132 and Scalextric SSD C704



SP46

Cable twist

with connector for Carrera (3x)



SP47

Noise motor filter for 02/SSD/
D132 in-car module (1x)

Digital system



SP32

Spare IR LED on wires
for oXigen and SSD chips



SP15d

Hornby digital Chip
for Scalextric SSD C7042 or Arc Pro system

75



SP43

Carrera digital Chip for Carrera D132 system



SP50

Set of clip chip holder (3x)

Analog controller

SCP2



SCP201ai
SCP-2 analog controller
home racing Replaces SCP201a
and SCP201i



SCP201fg
SCP2 electronic controller analog
with Common Ground High Current
Cartridge - For all slot cars



76

SCP201f
SCP2 Controller
without Cartridge



SCP201bc
Analog cartridge
for SCP-1, SCP-2 and SCP-3
electronic controllers



SCP201g
SCP2 analog common ground
(positive wiring) high current
cartridge 20a cont. - 40A peak



SCP204a-sh
Short stroke
trigger for SCP2

SCP304a-sh
Short stroke trigger for SCP3

SCP204a
SCP2 Complete Trigger Set

SCP304a
SCP3 Complete Trigger Set



Electronic controller

Spare parts

- SCP202a 
- SCP202b 
- SCP202e 

Complete shell (red, blue, lemon yellow)



SCP303a 
Buttons Kit (red)



SCP03b 
SCP03c 
Buttons Kit
(blue, lemon yellow)

77



SCP302a 
Complete shell (yellow)



SCP04f
Replacement cable
for high current cartridge (2m)



SCP04c
Replacement fuses
for SCP 3. 15A - fast (5x)



SCP04e
Spare silicon cable

Lighting kit



SP42

Leds and cables

for lighting kits SP06 and SP16c



78

SP16c

Universal lighting kit

for analogic, SSD Slot.it cars and oXigen

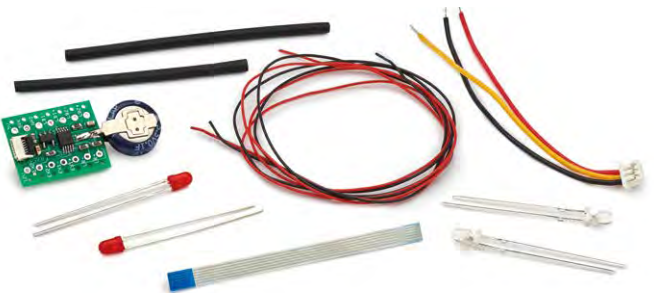

SP44

Universal light kit for analog and digital

SP48

Spare flat cables

for SP44 (2x)



Live Timing System

Supported by
PC Lap Counter



TS01a
Live timing box

Programmable
in 10 languages



TS02a
Track interface

79



TS02b
Track to telemetry cable



TS03a
Sector time expansion cable

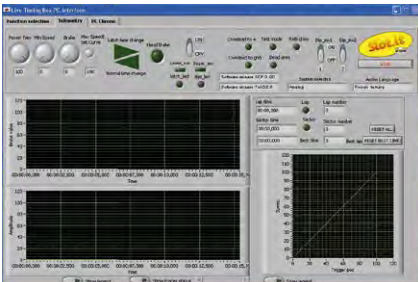

FREE
Live timing box PC
interface software.

D2A System



0206a

D2A box - Analog wireless system with digital features

80



0208a

Analog wireless system set with timing and digital features

Prints & Posters

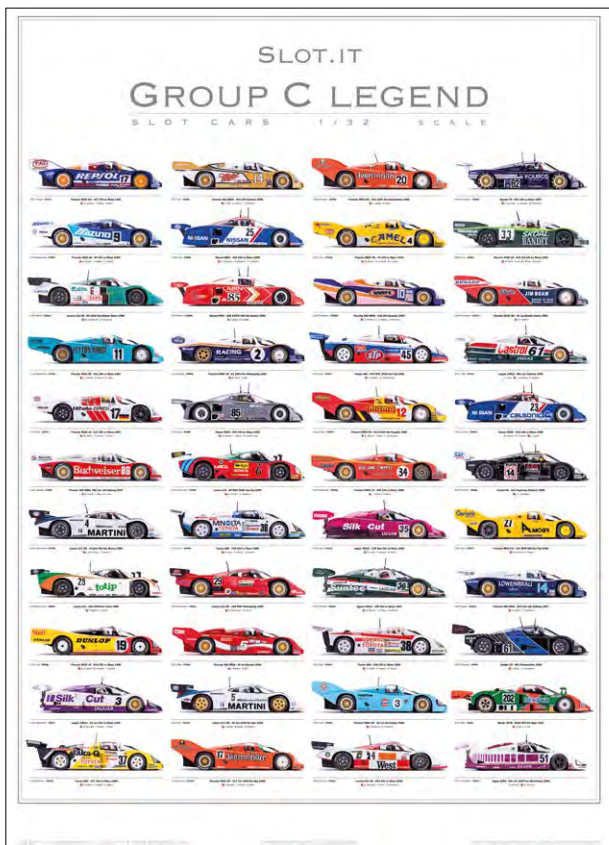

PGRC-2

Poster Slot.it
Group C Legend
(2011-2017)

PGRC-2s

Poster Slot it
Group C Legend
(2011-2017) - signed



banner

1m Slot.it banner (h 80cm)



banner - oXigen

2m oXigen banner (h 80cm)

Maintenance



SP39
Gear grease
(15g)



SP40
Performance oil
for motors (20ml)



SP41
Motor cleaner and protector (50ml)

Common Parts



SP49
Set of rubber antennas (2+2)

82 Packaging



SP09
Transparent box



SP36
Clamshell box
for 1:32 slot cars



SP35
Plastic spare parts containers
(d.17, h.50 mm)

Distributors

Italy

Galileo Engineering srl

via Cavallotti 16
42122 Reggio Emilia
Italia
Tel./Fax +39 0522 920496
info@slot.it
www.slot.it

Australia

Armchair Racer

7/19 Hotham Parade
Artarmon NSW 2064
Australia
Tel. +61 2 9906 5566
cathy@armchairracer.com.au
www.armchairracer.com.au

Brazil

B52 Modelismo

Rua Filinto de Almeida, 96
Santo André - SP
09190-020
Brazil
Tel. +5511 4425 2758
b52grp7@gmail.com
www.b52online.com.br

Brunei

Kingdom Rides & Adventures

unit 9, block A, Abraco
Industrial Park, Simpang 281
Lambak, Brunei BB1714
Tel: +673 7114970
info@mountainbikebrunei.com
jason@mountainbikebrunei.com

BeNeLux

Q.U.I.C.K.

Victoria Regiastraat, 32
1338 ZA - Almere
Tel: +31 36 5370853
fred.quick@upcmail.nl

Chile

Comercial Teba Limitada

Jugueteria Alemana
Huerfanos 875 L 27
Santiago - Chile
Tel: 0056 226393359
contacto@ja.cl
www.ja.cl

Czech Republic/ Slovakia

Modelracing.cz s.r.o.

Tel: +420 475205600
Mob: +420 775696300
Mob: +420 736505354
shop@modelracing.cz
www.modelracing.cz

France

Fair International

24 rue Pasteur
Za de Ragon
44119 Treillieres
Tel. +33 962 363409
Mob. +33 613 501077
Fax +33 240 592815
fairslot@wanadoo.fr
www.fairslot.com

Germany/ Austria

H+T Motor Racing GmbH

Bert - Brecht - Strasse 43
DE - 64291 Darmstadt
Tel. +49 (0) 6150 84801
Fax +49 (0) 6150 84803
info@ht-motorracing.com
www.ht-autorennbahn.de

Greece

Creative Hobby

17 Vrillission str.
15236 Pendeli, Athens
Greece
Tel./Fax +30 210 6135518
Mob. +30 6977204530
nisko@creativehobby.gr
www.creativehobby.gr

Japan

Eyestec Co.,Ltd

5-8-15Aihara, Midori-ku,
Sagamihara, Kanagawa,
252-0141 Japan
Tel: +81-42-703-5585
Fax: +81-42-703-5585
sales@getslot.jp
www.getslot.jp

Distributors

New Zealand P.R.C.

Ironhorse Hobbies Ltd

72 Treffers Road
Wigram
Christchurch 8042
New Zealand
Tel/Fax: +64 03 666 117
sales@ironhorsehobbies.co.nz
www.ironhorsehobbies.co.nz

Ju Su Culture

**Communication
(Shanghai) Co.LTD**
107, No. 671 Hutai Road,
Jing'an District, Shanghai
Tel. +86 13764621213
speed-frontline@qq.com

Singapore

InTrigg Hobbies

62 Ubi Road 1.
Oxley BizHub 2, #05-22.
Singapore 408734.
+65 8222-1330 (WhatsApp)
www.intrigg-hobbies.com
enquiries@intrigg-hobbies.com

Switzerland

Ors Kart Racing

Avenue des Pâquiers 22
2072 Saint-Blaise
Tel. +41 32 753 02 25
scx@orskartesting.com
www.orskartesting.com

84

South Africa

Redipak Wholesalers

Unit 5, 159 Greenvale Road
Wilbart, Germiston,
1609 Gauteng
Rep. of South Africa
Tel. +27 11 455 5990
Fax +27 86 662 8613
info@redipak.co.za
www.redipak.co.za

UK / Ireland

Gaugemaster Controls Ltd

Gaugemaster House,
Ford Road
Arundel, West Sussex,
BN18 0BN, United Kingdom
Tel. +44 (0) 1903 884 321
Fax +44 (0) 1903 884 377
sales@gaugemaster.com
www.gaugemaster.com

USA

Electric Dreams Slot Cars

606 Hawaii St. Unit B
El Segundo, CA 90245
+1-310-676-7600
shop@electricdreams.com
www.electricdreams.com

Stores

Italy

Bigi Modellismo

Via Bernardino Zacchetti, 4,
42124 Reggio Emilia RE
www.bigimodel.it

Crazy4Slot

Via del Cigno, 20
61122 Pesaro (PU)
Tel. +39 340 386 7130
www.crazy4slot.com

Franchi di Scarpa

Giuseppe
Via Padova 74,
20132 Milano
Tel. +39 02 2894967
www.franchidiscarpa.it

Hobbitalia 2 s.a.s.

di Barthel Federico e C.
via degli Artisti 11 d/e
50132 Firenze
tel. e fax +390555535499
hobbitalia2@virgilio.it

Libreria Semola snc

via De Amicis 5D
42025 Cavriago (RE)
Tel. +39 0522 371517
info@libreriasemola.it
www.libreriasemola.it

Magic Model di Gardini

Piero
via Felice Orsini 22 47121
Forlì
Telefono: 0543.27891
mail: magic.model@tin.it
www.magic-model.it

Marzi Otello s.a.s.

Piazza Filippo Carli, 19/20
00191 - Roma - RM
Tel: +39 06 3296455
www.slotcars.it

Modellismo Micro Macro snc

viale del lavoro 47 - 37036
San Martino Buon Albergo (VR)
Tel. +39 045 994554
www.modellismoveronamicromacro.com

Modellismo Uliano s.r.l.

info@modellismouliano.com
www.modellismouliano.com

Mularoni Marta Modellismo

Contrada dei Magazzeni 4/6
47890 C. Storico San Marino, San Marino
Tel.: +39 0549 991211
mularoni-marta-modellismo.business.site

Pit Stop Modellismo

Via G. Graziani, 73
41122 Modena
Tel. e Fax 059/452054
info@pitstopmodel.com
www.pitstopmodel.com

Slotracingstore

di Antonio Merlini
Via Filippo Marchetti 19
00199 Roma
Tel: 3478184582
www.slotracingstore.com

Toptoys srls

Via dei Granatieri, 3
00143 Roma
Tel. +39 0694375533
team@toptoys-italy.com
www.toptoys-italy.com

Tuttoslot Shop

Tel. 339/2396365
noleggi.tuttoslot.it

Wonderland Pavia Gilpavia srls

Via Pietro Nenni, 72/a,
27100 Pavia PV
Tel.: +39 331 84 79 510
wonderland-pavia.business.site

Stores

BeNeLux

Slotracing2go

info@slotracing2go.nl
www.slotracing2go.nl

Slotraceshop.nl

Lage Engweg 49A
3882BC Putten
tel. 0031341361185
info@slotraceshop.nl
www.slotraceshop.nl

Canada

Scale Racing

Center Toronto

145 Claireport Crescent
UNIT 5, Toronto, Ontario
M9W 6R6
Canada
Tel: 416-886-4299
emossetti@rogers.com

Denmark

LP-Sales v/Per Springborg

Bakkevej 12
DK-5450 Otterup
Phone: (+45) 61553016
lp-sales@mail.dk
www.dk-minirace.dk

Racerbaneshoppen.dk

Glerupvej 17
DK-2610 Rødovre
Phone: Per: +45 21734483
salg@racerbaneshoppen.dk
www.racerbaneshoppen.dk

France

Slot Car-Union

www.slotcar-union.com

Odsherreds

Slot Car Shop

Tigervej 2
4581 Rørvig, Denmark
info@oscs.dk, FB: oscs.dk
www.oscs.dk

SlotWorld.dk

Phone: +45 29 91 91 91
mail@slotworld.dk
www.slotworld.dk

86

Norway

Bralek.no

Vinsvoldveien 3
3302 Hokksund
Tel: (+47)
46908301
post@bralek.no
www.bralek.no

Portugal

MeoSlot

Complexo industrial das
eiras caminho da igreja n.24
9125-138 caniço Madeira
Portugal
Tel: 00351291628823
meoslot@gmail.com
www.meoslot.com

SlotMadeira

sales@slotmadeira.pt
MadSlot - Virgilio

Sweden

Agico AB

Sandgatan 10
247 62 VEBERÖD
SWEDEN
Phone: +46 730 584 995
info@slotcar4fun.se
www.slotcar4fun.se

Bromma Hobby AB

Krossgatan 25, 16250
Vällingby.
Tel. +46-(0)8 410 208 08
info@brommahobby.se
www.brommahobby.com

Fritsla Hobby + Hobbia

Bäckabovägen 5
511 71 Fritsla
Tel: +46 708570166
info@hobbia.se
hobbia.se

Spain

Cric Crac

www.criccrac.com

La Masia, 28

(Ctra N-II Km 559)

08711 Òdena (Igalada)

Tel. +34 93 804 0015

Whatsapp: +34 671 629 311

Evotec Shop S.L.

+34 675 653 294

info@evotecshop.com

www.evotecshop.com

Factory Slot

Km 345 Centro Comercial

Factory Bonaire,

ALDAIA, VALENCIA

factoryslot@gmail.com

Model Hobby Red

Calle Nuestra Señora

de la Luz, n. 24

28025 Madrid

+34 611 107 335

info@model-hobbyred.com

www.model-hobbyred.com

Slotforyou

Tel.: 935286016

Móvil: 626584072

www.slotforyou.es

Slotmania

Calle Muntaner, 83

CP: 08011 Barcelona

(España)

+34 934548686

Whatsapp: +34 630272862

info@gruposlotmania.net

www.gruposlotmania.net

Speed Slot

Centro comercial Getafe 3

avenida Juan Carlos I n.1

28905 Getafe (Madrid)

tel. 0034 619 24 62 48

USA

Electric Dreams Slot Cars

606 Hawaii St. Unit B El

Segundo, CA 90245

+1-310-676-7600

shop@electricdreams.com

www.electricdreams.com

Scale Racing Center

3723 S Lawrence St

Tacoma WA 98409

tel. 1-253-564-1445

www.scaleracing.com

www.132slotcar.us

VRC Hobbies

78 Horseblock Rd. Unit 9

Yaphank, NY 11980, USA

+1-516-462-0696

www.vrchobbies.com

Great Traditions

13004 Kelvin Ave.

Philadelphia, PA 19116

Phone +1- 215-969-8694

customercare@gtslotcars.com

www.gtslotcars.com

LEB Hobbies, LLC

655 Leslie Lane

Yardley, PA 19067

215-493-4821

sales@lebhobbies.com

www.lebhobbies.com

Clover Leaf Racing

1246 South Milford Road

Milford Michigan 48357

313-473-SLOT

cloverleafracing@gmail.com

www.cloverleafracing.com

Professormotor Inc.

1235 Industrial Drive Suite 10

Saline MI 48176

professor@professormotor.com

www.professormotor.com

Cincyslots

2172 Seymour Ave

Cincinnati, Ohio 45237

Phone +1-513-731-3304

g2172@aol.com

cincyslots.com

Colpar's Hobbytown

1915 S Havana St

Aurora, CO 80014

+1-303-341-0414

fred@colpar.com

www.hobbytown.com

Scale Auto Racing LLC

11303 Jones Rd West, Ste C

Houston, Texas 77095

+1-806-606-6710

info@houstonsscaleautoracing.com

sales@houstonsscaleautoracing.com

www.houstonsscaleautoracing.com

UK

Pendle Slot Racing

49 Churchill Way, Lomeshaye Ind Est,

Nelson, Lancashire, BB9 6RT, UK

info@pendleslotracing.co.uk

www.pendleslotracing.co.uk

POLICAR

Slot CARS

TRACK &
ACCESSORIES

1:32-SCALE

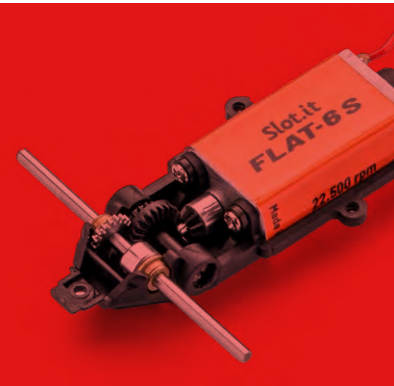

policar.it



Galileo Engineering

Galileo Engineering srl
via Cavallotti 16
42122 Reggio Emilia, Italy
E-mail: info@slot.it



policar.it





Index

- 4 CLASSIC F1 Spare Parts
- 10 LOTUS 72 Spare Parts
- 12 MARCH 701 Spare Parts
- 14 FERRARI 312 B2 Spare Parts
- 16 BRM P160/ P153 Spare Parts
- 18 FERRARI 126 C2 Spare Parts
- 20 MONOPOSTO 2018 Spare Parts
- 21 MONOPOSTO 2024 Spare Parts
- 22 CLASSIC F1 White Kit
- 23 TYRES & WHEELS
- 26 HOME RACERS Spare Parts
- 28 POLICAR TRACK

CLASSIC F1 Spare Parts



PCH01

F1 '70 narrow motor mount



PCH03

'70 wide motor mount

4



PCH08

F1 '80 narrow motor mount



PCH09

F1 '80 wide motor mount

ONLY for CAR07
an CAR10 cars



PCH10 F1 motor mount for FLAT type motors



PPI429o20-bg

9 teeth conical pinion internal Ø: 2mm (2x)

CLASSIC F1 Spare Parts

Assembled F1 '70 narrow motor mount with bevel gears



- PCH01-45z15** ● axle 45mm, Z15 crown, Ø6,84 mm
- PCH01-45z16a** ○ axle 45mm, Z16 crown, Ø7,22 mm
- PCH01-45z17** ● axle 45mm, Z17 crown, Ø7,6 mm
- PCH01-45z18** ● axle 45mm, Z18 crown, Ø7,6 mm
- PCH01-45z18a** ● axle 45mm, Z18 crown, Ø7,95 mm
- PCH01-51z15** ● axle 51mm, Z15 crown, Ø6,84 mm
- PCH01-51z16a** ○ axle 51mm, Z16 crown, Ø7,22 mm
- PCH01-51z17** ● axle 51mm, Z17 crown, Ø7,6 mm
- PCH01-51z18** ● axle 51mm, Z18 crown, Ø7,6 mm
- PCH01-51z18a** ● axle 51mm, Z18 crown, Ø7,95 mm
- PCH01-54z15** ● axle 54mm, Z15 crown, Ø6,84 mm
- PCH01-54z16a** ○ axle 54mm, Z16 crown, Ø7,22 mm
- PCH01-54z17** ● axle 54mm, Z17 crown, Ø7,6 mm
- PCH01-54z18a** ● axle 54mm, Z18 crown, Ø7,95 mm

5

Assembled F1 '70 wide motor mount with bevel gears



- PCH03-45z15** ● axle 45mm, Z15 crown, Ø6,84 mm
- PCH03-45z16a** ○ axle 45mm, Z16 crown, Ø7,22 mm
- PCH03-45z17** ● axle 45mm, Z17 crown, Ø7,6 mm
- PCH03-45z18** ● axle 45mm, Z18 crown, Ø7,6 mm
- PCH03-45z18a** ● axle 45mm, Z18 crown, Ø7,95 mm
- PCH03-51z15** ● axle 51mm, Z15 crown, Ø6,84 mm
- PCH03-51z16a** ○ axle 51mm, Z16 crown, Ø7,22 mm
- PCH03-51z17** ● axle 51mm, Z17 crown, Ø7,6 mm
- PCH03-51z18** ● axle 51mm, Z18 crown, Ø7,6 mm
- PCH03-51z18a** ● axle 51mm, Z18 crown, Ø7,95 mm
- PCH03-54z15** ● axle 54mm, Z15 crown, Ø6,84 mm
- PCH03-54z16a** ○ axle 54mm, Z16 crown, Ø7,22 mm
- PCH03-54z17** ● axle 54mm, Z17 crown, Ø7,6 mm
- PCH03-54z18a** ● axle 54mm, Z18 crown, Ø7,95 mm

CLASSIC F1 Spare Parts

Assembled F1 '80 narrow motor mount with bevel gears



- PCH08-45z15** ● axle 45mm, Z15 crown, Ø6,84 mm
- PCH08-45z16a** ○ axle 45mm, Z16 crown, Ø7,22 mm
- PCH08-45z17** ● axle 45mm, Z17 crown, Ø7,6 mm
- PCH08-45z18** ● axle 45mm, Z18 crown, Ø7,6 mm
- PCH08-45z18a** ● axle 45mm, Z18 crown, Ø7,95 mm
- PCH08-51z15** ● axle 51mm, Z15 crown, Ø6,84 mm
- PCH08-51z16a** ○ axle 51mm, Z16 crown, Ø7,22 mm
- PCH08-51z17** ● axle 51mm, Z17 crown, Ø7,6 mm
- PCH08-51z18** ● axle 51mm, Z18 crown, Ø7,6 mm
- PCH08-51z18a** ● axle 51mm, Z18 crown, Ø7,95 mm
- PCH08-54z15** ● axle 54mm, Z15 crown, Ø6,84 mm
- PCH08-54z16a** ○ axle 54mm, Z16 crown, Ø7,22 mm
- PCH08-54z17** ● axle 54mm, Z17 crown, Ø7,6 mm
- PCH08-54z18** ● axle 54mm, Z18 crown, Ø7,6 mm
- PCH08-54z18a** ● axle 54mm, Z18 crown, Ø7,95 mm

6

Assembled F1 '80 wide motor mount with bevel gears



- PCH09-45z15** ● axle 45mm, Z15 crown, Ø6,84 mm
- PCH09-45z16a** ○ axle 45mm, Z16 crown, Ø7,22 mm
- PCH09-45z17** ● axle 45mm, Z17 crown, Ø7,6 mm
- PCH09-45z18** ● axle 45mm, Z18 crown, Ø7,6 mm
- PCH09-45z18a** ● axle 45mm, Z18 crown, Ø7,95 mm
- PCH09-51z15** ● axle 51mm, Z15 crown, Ø6,84 mm
- PCH09-51z16a** ○ axle 51mm, Z16 crown, Ø7,22 mm
- PCH09-51z17** ● axle 51mm, Z17 crown, Ø7,6 mm
- PCH09-51z18** ● axle 51mm, Z18 crown, Ø7,6 mm
- PCH09-51z18a** ● axle 51mm, Z18 crown, Ø7,95 mm
- PCH09-54z15** ● axle 54mm, Z15 crown, Ø6,84 mm
- PCH09-54z16a** ○ axle 54mm, Z16 crown, Ø7,22 mm
- PCH09-54z17** ● axle 54mm, Z17 crown, Ø7,6 mm
- PCH09-54z18** ● axle 54mm, Z18 crown, Ø7,6 mm
- PCH09-54z18a** ● axle 54mm, Z18 crown, Ø7,95 mm

CLASSIC F1 Spare Parts

Assembled F1 motor mount
for flat type motors with bevel gears



- PCH10-51z15** ● axle 51mm, Z15 crown, Ø6,84 mm
- PCH10-51z16** ○ axle 51mm, Z16 crown, Ø7,22 mm
- PCH10-51z17** ● axle 51mm, Z17 crown, Ø7,6 mm
- PCH10-51z18** ● axle 51mm, Z18 crown, Ø7,95 mm

Gear Ratios

Optional
Z9 pinion

25/15 teeth - Z18
New Gear Ratio
3.34

Z25-15
(PGI2515-bg)



Z18
(PGS7918-..)



Optional
On production models

25/16 teeth - Z17
STD Gear Ratio
2.94

Z25-16
(PGI2516-bg)



Z17
(PGS8017-..)



Optional
Z9 pinion

25/17 teeth - Z16
New Gear Ratio
2.61

Z25-17
(PGI2517-bg)



Z16
(PGS7216-..)



Optional
Z9 pinion

25/18 teeth- Z15
New Gear Ratio
2.30

Z25-18
(PGI2518-bg)



Z15
(PGS6815-..)



CLASSIC F1 Spare Parts

PMX01 F1 DFV-25K RPM
motor dual open/closed case sides



PPI429o15 9 teeth pinion,
external \varnothing :4.2 mm
internal \varnothing :1.5 mm, brass (2x)



PMX01-k F1 DFV-25K RPM
motor dual o/c case sides, knurled shaft



PPI429o15-bg 9 teeth pinion,
conical pinion internal \varnothing :1.5 mm (2x)



8

PGI2515-bg F1 plastic bevel gear
with axle and spacer, Z25/Z15



PGI2516-bg F1 plastic bevel gear
with axle and spacer, Z25/Z16



PGI2517-bg F1 plastic bevel gear
with axle and spacer, Z25/Z17



PGI2518-bg F1 plastic bevel gear
with axle and spacer, Z25/Z18



PPA01 Set of 4 bushings
for F1 motor mounts



PPA02 Stopper
with M2xL2 mm hexagonal screw



PCH04 Motor mount screws
M1.4 x 2.5 mm, 4pcs.



PCH05 Metric screws
M2 x 3.8 mm, brass, (5x)



PCH06 Metric screws
M2 x 7mm, brass, (5x)



PCH07 Metric screws
M2 x 5 mm, brass, (5x)



PGS6815-45 Ø6,84 mm, 15 teeth gear with 45mm axle
PGS7216-45 Ø7,22 mm, 16 teeth gear with 45mm axle
PGS7617-45 Ø7,6 mm, 17 teeth gear with 45mm axle
PGS7918-45 Ø7,95 mm, 18 teeth gear with 45mm axle

PGS8016-45 Ø7,6 mm, 16 teeth gear with 45mm axle
PGS8018-45 Ø7,6 mm, 18 teeth gear with 45mm axle

PGS6815-51 Ø6,84 mm, 15 teeth gear with 51mm axle
PGS7216-51 Ø7,22 mm, 16 teeth gear with 51mm axle
PGS7617-51 Ø7,6 mm, 17 teeth gear with 51mm axle
PGS7918-51 Ø7,95 mm, 18 teeth gear with 51mm axle

PGS8016 Ø7,6 mm, 16 teeth gear with 51mm axle
PGS8018 Ø7,6 mm, 18 teeth gear with 51mm axle

PGS6815-54 Ø6,84 mm, 15 teeth gear with 54mm axle
PGS7216-54 Ø7,22 mm, 16 teeth gear with 54mm axle
PGS7617-54 Ø7,6 mm, 17 teeth gear with 54mm axle
PGS7918-54 Ø7,95 mm, 18 teeth gear with 54mm axle

PGS8016-54 Ø7,6 mm, 16 teeth gear with 54mm axle
PGS8018-54 Ø7,6 mm, 18 teeth gear with 54mm axle

LOTUS 72 Spare Parts



PCS02t
Lotus 72 chassis



PCS02i
Lotus 72 wheels inserts (2x + 2x)



PCS02b1
Lotus 72 body (type A)



PCS02b2
Lotus 72 body (type B)

10



PCS02v Lotus 72 transparent parts



PCS02p1 Lotus 72 spare parts A



PCS02p2 Lotus 72 spare parts B

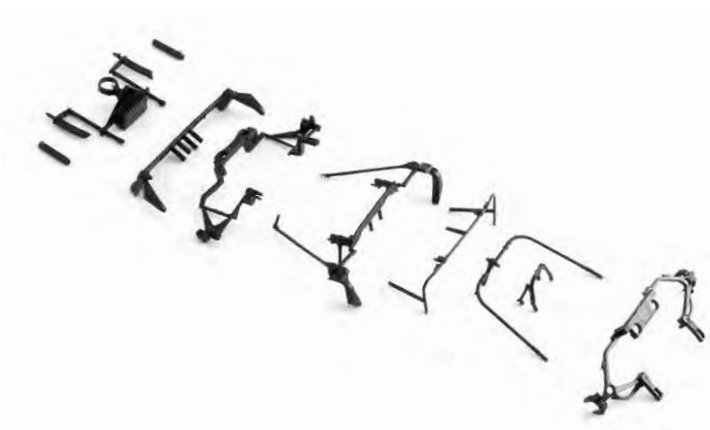

PCS02p3 Lotus 72 spare parts C



PCS02p4 Lotus 72 spare parts D

MARCH 701 Spare Parts



PCS04t-a March 701 chassis



12 **PCS04i** March 701 wheel inserts (2x + 2x)



PCS04b March 701 body



PCS04p1 March 701 spare parts A



PCS04p2 March 701 spare parts B



PCS04v March 701 trasparent parts

FERRARI 312 B2

Spare Parts



PCS05t1
312B2 chassis type 2



PCS05b2
312B2 body type 2

14



PCS05t2
312B2 chassis type 1



PCS05b1
312B2 body type 1



PCS05v
312B2 transparent parts



PCS05p1
312B2 spare parts A



PCS05p2 312B2 spare parts B



PCS05p3 312B2 spare parts C



PCS05i 312B2 kit wheel inserts (2+2+2)

BRM P160/P153

Spare Parts



PCS08v P160/P153 transparent parts

16



PCS08b 160 body



PCS08t P160/P153 chassis



PCS08i P160/P153 kit wheel inserts (4+4+2)



PCS08p1 P160/P153 spare parts type A

17



PCS08p2 P160 spare parts type B



PCS08p3 P153 spare parts type B

FERRARI 126 C2

Spare Parts



18 **PCS09p1** 126 C2 spare parts A

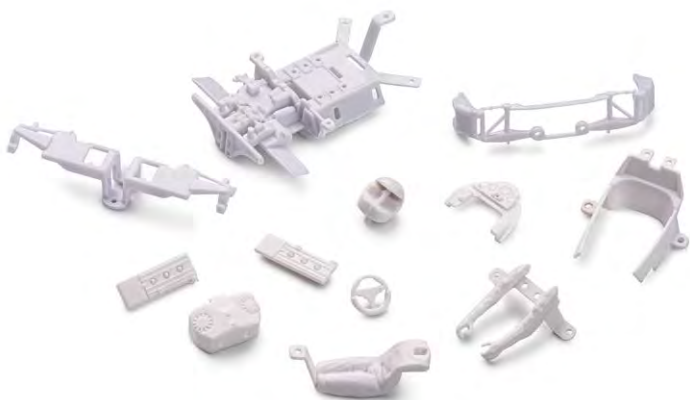

PCS09p2 126 C2 spare parts B



PCS09v 126 C2 transparent parts



PCS09b 126 C2 body

19



PCS09t 126 C2 chassis



PCS09i 126 C2 wheel insert (2x + 2x)

MONOPOSTO 2018

Spare Parts



PCS07t1a
Monoposto chassis
standard rev1



PCS07t2a
Monoposto chassis
digital version rev1



20 **PCS07p**
Monoposto spare parts



PCS07p1
Monoposto
front wing clips (12x)



PCS07p2
Monoposto front
suspension set



PCS07i
Monoposto kit
wheel inserts (2+2)



PCS07b Monoposto body kit

MONOPOSTO 2024

Spare Parts



PCS10t Monoposto '24 chassis



PCS10b Monoposto '24 body



PCS10p Monoposto '24 spare parts



PCS10i Monoposto '24 wheel inserts (2+2)

CLASSIC F1 White kit (not assembled)



CAR02z

Lotus 72 white kit

CAR04z1

March 701 white kit

CAR05z

312B2 white kit

CAR05z1

312B2 white kit type 2

CAR08z1

P160 white kit

CAR08z2

P153 white kit

CAR09z

126 C2 white kit

22

CARS Spare Parts

	MODEL		
	312PB	F40	330 P4/412P
CODE	CAR01	CAR03	CAR06
CHASSIS	PCS01t	PCS03t	PCS06t
SPARE PARTS	PCS01p	PCS03p	PCS06p
TRANSPARENT PARTS	PCS01v	PCS03v	PCS06v
WHEEL INSERTS	PCS01i	-	PCS06i
WHITE KIT	-	-	CAR06z
BODY KIT	KIT01	-	PCS06b
COCKPIT	-	PCS03cp	PCS06lx

TYRES & WHEELS

Rear \emptyset 16mm (Classic formula)



PPT1219C1

C1 compound,
F1 rear tyre for \emptyset 16mm (eq. 15") wheels (4x)



PPT1310F22

PPT1310G25

PPT1310C1

F22-G25-C1 compound,
F1 rear tyre, slick, for \emptyset 16mm (eq. 15") wheels (4x)

23



PW16011724P

 ex PWH1217-PI

PI \emptyset 16x11.7mm F1 rear wheels, 0.8g (4x) - eq. 15"



PW16011724A

 ex PWH1234-AI

AI \emptyset 16x11.7mm F1 rear wheels, M2 grub, 1.8g (2x) - eq. 15"

TYRES & WHEELS

Front Ø 13.8mm (Classic formula)



PPT1220C1

C1 compound,
F1 front tyre for Ø13.8mm wheels (4x)



PW13807921P

 ex PWH1218-PI

PI Ø13.8x7.9mm F1 front wheels, 0.5g (4x)

24

Rear Ø 13.8mm (Classic & Monoposto 2018)

PPT1224F22

PPT1224G25

PPT1224C1

F22-G25-C1 compound,
F1 rear tyre, slick, for Ø13.8mm (eq. 13") wheels (4x)



PW13813519P

PI Ø13.8x13.5mm F1 rear wheels, 0.5g (4x) – eq. 13"



PW13813519A

Al Ø13.8x13.5mm F1 rear wheels, M2 grub, 1.8g (2x) – eq. 13"

TYRES & WHEELS

Front Ø 13.8mm (Monoposto 2018)

PPT1354C1

C1 compound,
F1 front tyre for Ø13.8mm wheels (4x)



PW13810504P

PI Ø13.8x10.5mm F1 front wheels, 0.5g (4x)



Rear Ø 17.3mm (Monoposto 2024)

25

PPT1405G25

PPT1405F22

PPT1405C1

G25-F22-C1 compound,
F1 rear tyre, slick, for Ø17.3mm (eq. 18") wheels (4x)



PW17313515A

Al Ø17.3x13.5mm F1 rear wheels, M2 grub, 1.8 (2x) - eq. 18"



HOME RACERS

Spare Parts



HR01

Pickup set for Home Racers car



HR02

Copper braids for Home Racers car (4x)



HR03

GT86 spare chassis



HR04

Polycarbonate cockpit for Policar Toyota GT86 - CT01

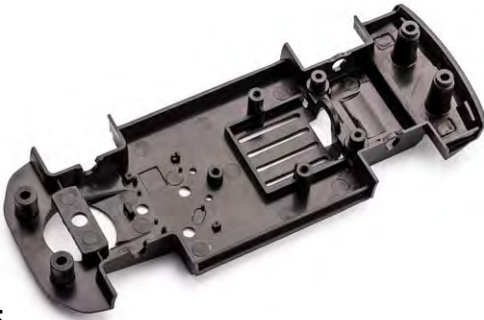

HR05

WRX STI spare chassis



HR06

Polycarbonate cockpit for WRX STI - CT02

27

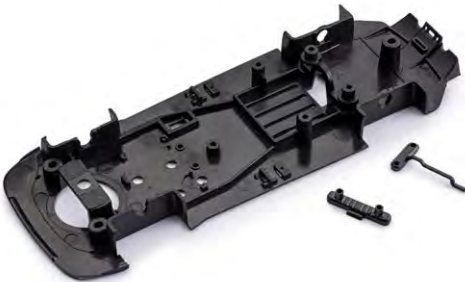

HR07

GT4 spare chassis



HR08

V12 13.6K RPM motor 60g*cm
spare motor for 'CT' cars



HR09

Rear mirrors set for
CT01 and CT02

POLICAR



POLICAR, the brand that was synonym of slot car racing in Italy in the 60's, returns with innovative solutions for a completely new track system. POLICAR's new design and ideas bring back the fun and excitement of slot car racing! Lanes are set apart by 9 cm, the ideal lane spacing for 1/32 racing, and the surface texture is good for rubber and sponge tyres alike. The 6 cm extra wide borders slide securely into the side of the track, and the guardrails are kept firmly in place. Bridges and ramps are easy and stable. Rails are made of stainless steel.



POLICAR TRACK

Racing Track System



P008-4

Full length straight, 358mm (4x)

30



P002-6

Straight border, 179mm (6x)



P023-4

Half length straight, 179mm (4x)



P091-4

Single lane half length
straight, 179mm (4x)



31

P015-1

Analog powerbase with border for lane 1 and 2 (1x)



P016-1

Analog powerbase with border for lane 3 and 4 (1x)



P092-4

Single lane 61.4 length
straight, 61.4mm (4x)



P024-4

32 61.4 length straight, 61.4mm (4x)



P061-6

61.4 straight border, 61.4mm (6x)



P046-2

Polistil & Fleischmann
adapter, 61.4mm (2x)



P059-6

End border left (6x)



P060-6

End border right (6x)



P075-10

Locking clips for curves (10x)



P074-10

Locking clips for straights (10x)



P076-20

Intersection
locking clips (20x)



P006-2

Ninco adapter, 179mm (2x)



34

P007-4

Spare clips for Ninco adapter (4x)



P009-4

R1 45° Curve (4x)



P051-6

Inner border for R1 curve
22.5° (6x)



P053-6

Outer border for R1 curve
22.5° (6x)



P013-4
R1 22.5° Curve (4x)



P014-2
R2 45° Curve (2x)



P052-6
Inner border for R2 curve
22.5° (6x)



P054-6
Outer border for R2 curve
22.5° (6x)

35



P043-2
R2 22.5° Curve (2x)



P044-2

R3 22.5° Curve (2x)



P055-6

Inner border for R3 curve
22.5° (6x)



P056-6

Outer border for R3 curve
22.5° (6x)



P045-2

R4 22.5° Curve (2x)



P057-6

Inner border for R4 curve
22.5° (6x)



P058-6

Outer border for R4 curve
11.25° (6x)



P077-4

R5 11.25° Curve (4x)



P071-6

Inner border for R5 curve
11.25° (6x)



P072-6

Outer border for R5 curve
11.25° (6x)

37

OXIGEN
SLOT.IT DIGITAL



P090-1

oXigen double lane changer 716mm (1x)

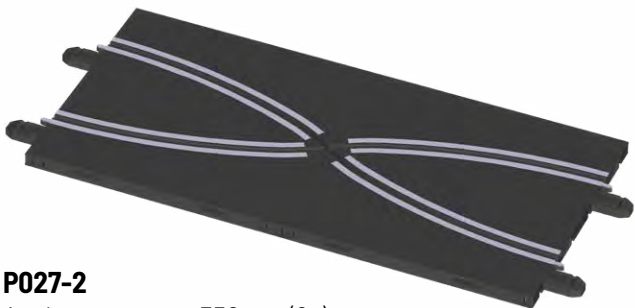

P027-2

Analog crossover 358mm (2x)



38

P098-1

2 lanes dead strip with connectors 179mm (1x)



P097-1

4 lanes dead strip with bluetooth module (1x)



P096-1

Dead strip for lane 1 & 2 with bluetooth module (1x)



P099-1

Policar spring rails set (8+8x, spring length 1m)



P030-10

Contact springs with fastons for Policar track (10+10x)



40



P073-6

1m Barrier and clips set (6x)
"To use without borders"





P020-10

Guardrail 25cm white - 10pcs



P020g-10

Guardrail 25cm grey - 10pcs



P010-4

Bridge set (4x)

41



P-Banner-W

P-Banner-B

P003EU-1

5-13.5V adjustable power supply - EU

P003US-1

5-13.5V adjustable power supply - US

P003UK-1

5-13.5V adjustable power supply - UK

P003AU-1

12V power supply - AU



P029-1

Black controller (1x)



P028-1

Red controller (1x)



P018-1a

Banana to 3.5mm stereo jack adapter



P019-1

Polarity inversion cable



T002z / T002z-UK / T002z-AU / T002z-US

6.6m 2 lanes starter set - 2.5x1.6m assembled dimensions



T003z / T003z-UK / T003z-AU / T003z-US

6.5m 4 lanes starter set - 2.9x1.8m assembled dimensions



T004z / T004z-UK / T004z-AU / T004z-US

9.2m 4 lanes starter set - 3.8x2.2m assembled dimensions
