

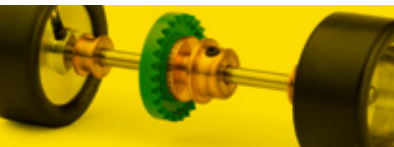

# Slot CARS

## ACCESSORIES

1:32·SCALE



slot.it



**Galileo  
Engineering**

Galileo Engineering srl  
via Cavallotti 16  
42122 Reggio Emilia, Italy  
E-mail: info@slot.it

# Index

4	HRS2 Ready to run	62	Bushing & Pulleys
9	Chassis spares	62	Magnets
10	Cable/Braids/Terminals	62	Ballast
11	Pickups	63	Suspensions
14	Motor configuration	64	Screwdrivers
16	Motor mounts	64	Screws
24	Conversion Kit	66	Cars spare parts
26	4WD System	70	E-bay shop
28	Motors	71	oXigen Digital System
32	Pinions	72	Digital System
35	Extractor/Press	76	Electronic Analog Controller
38	Sidewinder Spur Gears	78	Lighting kit
39	Modular crown	79	Live Timing System
41	Inline Crown Gears	80	D2A System
43	Anglwinder Gears	81	Prints & Posters
45	Gear Ratios	82	Maintenance
46	Starter Kit	82	Common Parts
48	Wheels	82	Packaging
53	Axle and Spacer	83	Distributors
54	Plastic inserts	85	Stores
60	Tyres		



# HRS<sup>2</sup> Chassis

The HRS chassis is a fully configurable, universal plastic chassis for slot cars. It comprises four main parts: main chassis, front chassis, motor mount, and body mounting means.

## ADJUSTABLE WHEELBASE

The front chassis can be positioned freely within a wheelbase between 64 and 90 mm.

## SELECTABLE FRONT AXLE POSITION

The front axle can be placed in one of two possible positions, one of which completely adjustable, making it easy to adjust the distance from the pickup.

## FLEXIBLE ASSEMBLY SYSTEM

The chassis and the body can be joined with either four mounting posts and cups (HRS1 style), two three-posts sidebars, or, on some cars, where possible, with the car's own screw holes.

# HRS<sup>2</sup> Ready to run



CH31f

## Sidewinder HRS2

Ready to run HRS2 chassis

OFFSET 0.5 mm

19 mm  $\odot \rightarrow \odot$  64/90 mm  $\square \leftarrow \square$  57/61 mm

4

# HRS<sup>2</sup> Ready to run



CH109e

## Inline HRS2

Ready to run HRS2 chassis

OFFSET 0.5 mm

19 mm  $\odot \rightarrow \odot$  64/90 mm  $\square \leftarrow \square$  56/61 mm



CH32f

## Anglewinder HRS2

Ready to run HRS2 chassis

OFFSET 1.0 mm

19 mm  $\odot \rightarrow \odot$  64/90 mm  $\square \leftarrow \square$  60.6/64 mm

Wheel inserts type may be different

Wheel inserts type may be different

5

# HRS<sup>2</sup> Starter kit



CH34b  
**Inline HRS2**  
Chassis starter kit  
OFFSET: 0.0 mm

6

# HRS<sup>2</sup> Starter kit



CH35  
**Angler HRS2**  
Chassis starter kit  
OFFSET: 0.0 mm

7

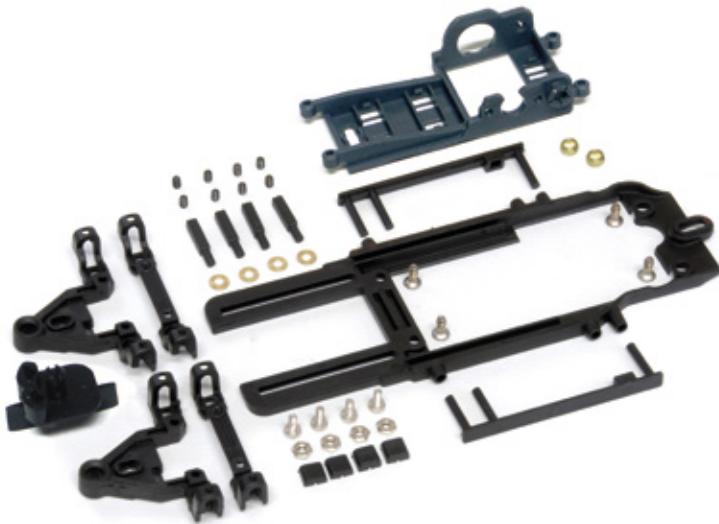

CH33b  
**Sidewinder HRS2**  
Chassis starter kit  
OFFSET: 0.5 mm



CH36  
**Chassis-to-body HRS2**  
connecting cups and spare parts



# HRS<sup>2</sup> Spare parts



CH37  
**Main Inline/ Sidewinder HRS2**  
Chassis



CH38  
**Main Anglewinder HRS2**  
Chassis



CH42  
**Chassis-to-body HRS2**  
connecting cups - (4x + 2x)

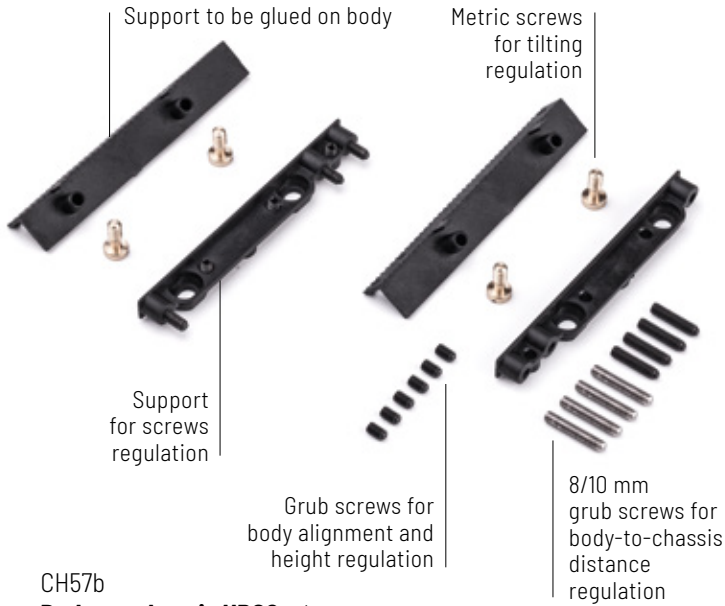

CH57b  
**Body-to-chassis HRS2** adapter

Support to be glued on body

Metric screws for tilting regulation

Support for screws regulation

Grub screws for body alignment and height regulation

8/10 mm grub screws for body-to-chassis distance regulation

# Chassis spares

SP07  
**Interchangeable spacers**  
for front axle regulation (2+2+2+2)



CH79b  
**Chassis common parts**



CH50p  
**Replacement plastic parts for SCX digital**



CH72  
**Plastic retainer nuts (6x)**

USE WITH CH51 SCREWS



# Cable/Braids/Terminals

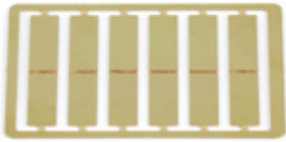

SP37  
**LMP pre-cut brass tabs**  
for pickup



SP22b  
**Silicon cable high flexibility**  
(1m)

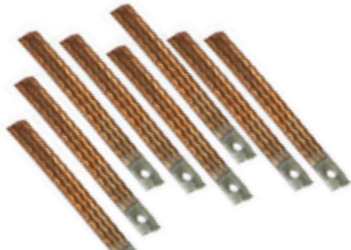

10 SP29  
**LMP copper braid** - (8x)



SP45  
**Cable with connectors**  
for motors - (3x)



SP04  
**Brass terminal**  
ø 1.5 L4 mm (10x)  
motor cable and independent  
front wheels axle



SP17  
**Brass terminals**  
ø 1.6 L5 mm (10x)



SP19  
**Copper braid** (1m)



SP18  
**Tin plated copper braid** (1m)

# Pickups



CH66  
**Clip racing pickup rev. B**  
Standard Slot.it models



CH26  
**Clip racing pickup**  
Old standard Slot.it models



CH10  
**Screw universal Pickup**



CH07  
**Screw pickup for wooden track**



CH85  
**Screw racing pickup**  
for standard Slot.it models



CH17  
**Clip short shaft pickup**



CH06  
**Clip long shaft pickup**



CH85d  
**Advanced blade screw pickup**

# LMP Pickups



CH88b  
LMP screw racing pickup rev. C Standard Slot.it LMP models



CH111  
LMP screw racing pickup for 4WD system

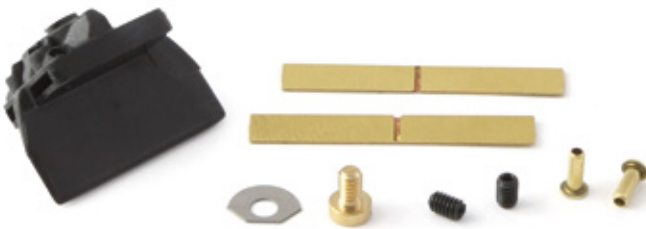

CH112  
LMP screw racing pickup for wooden track



CH84  
LMP screw pickup for wooden track



# Motor configuration

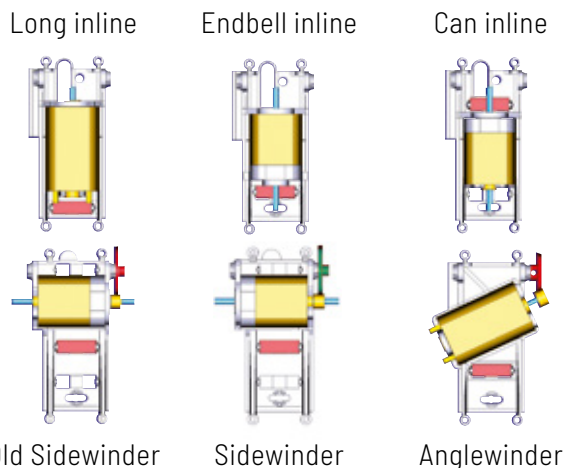

The Slot.it motor mounts allow easy installation of short and long can type motors configured as inline, sidewinder, or anglewinder. The 'offset' concept enables upwards displacement of the rear shaft with regards to the bottom plane of the chassis and to the motor drive shaft, thus lowering the stance of the back of the car, to fine tune the ground clearance depending on type of track, wheels, tyres and motor, and desired model behaviour. 'Offset' is the vertical displacement, in mm, between the centres of the rear axle and of the motor shaft.

A further advantage of the 'Offset' principle is that the rear wheel can be properly positioned, vertically, inside the wheel arch of the bodywork.

In the '0.0' versions the motor shaft and the rear axle lie on the same plane, whereas in the 'offset' versions, unique to Slot.it, the rear axle is offset upwards, thus lowering the center of gravity of the car and increasing the magnetic traction which either the car magnet or the motor exert on the track.

Available offset motor mounts range from 0.0 to 1.25mm, depending on the selected motor mount type. Another unique feature of the Slot.it motor mount are the self-aligning gimbal bushings. Traditional cylindrical bushings cannot compensate for chassis torsion and bad alignment; Slot.it spherical bushing self adjust themselves to guarantee the minimum possible friction and can be made with optimal tolerances to eliminate excessive play.

# Motor configuration

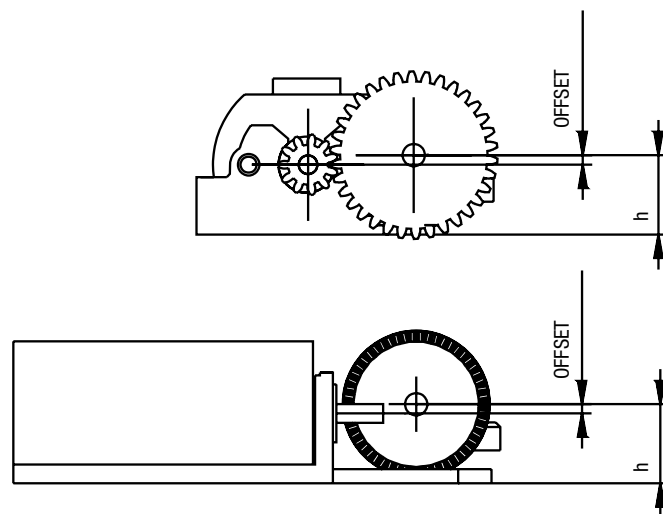

## Offset Description

OFFSET (mm)	h (mm)	ITEMS		
0.0	7.5	CH13c CH48b CH34b	CH61 CH76 KK11 CH35	CH48b CH117c
0.5	8.0	CH31f CH33b CH60b1 CH60c	CH67 CH70 CH75 KK13b	CH109e CH110 CH114 CH118b
0.75	8.25	CH68	CH69	
1.0	8.5	CH24b CH32f CH49b CH65	CH74 CH82 KK10b KK12b KK14c	KK16b CH115b CH119b
1.25	8.75	CH123 CH124	CH130 CH131	



# Motor mount

## Anglewinder 0.0 Offset

for Boxer / Flat-6 motors



CH61 **Hard** - black

CH61c **Carbon fiber** - black

# Motor mount

## Anglewinder 0.5 Offset

for Boxer / Flat-6 motors



CH60b1 **Hard** - grey

CH60c **Carbon fiber** - black

16



CH117c

**Carbon fiber** - black

To be used with CH105 bearing

17



CH118b **Hard** - grey

CH118c **Carbon fiber** - black

To be used with CH105 bearing

## How to identify offset of carbon fiber anglewinder

motor mounts - bearing version

Look in the direction of the bearing seat and check the dots

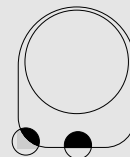

1.25mm  
CH124

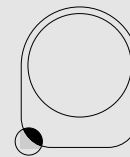

1.0mm  
CH119c

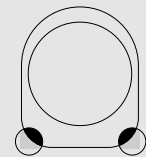

0.5mm  
CH118c

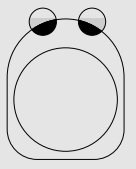

0.0mm  
CH117c

# Motor mount

## Anglewinder 1.0 Offset

for Boxer / Flat-6 motors



CH74

**Medium** - no pigment

**GT-LMP box stock models**

18

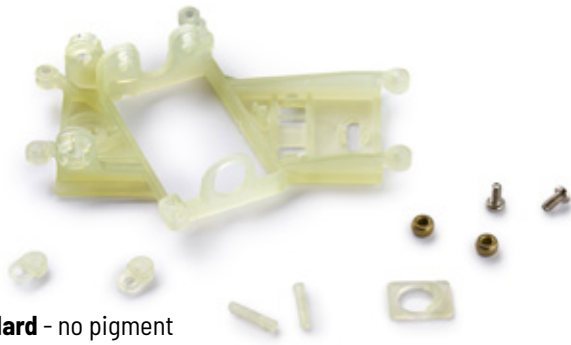

CH82b **Hard** - no pigment

CH82c **Carbon fiber** - black

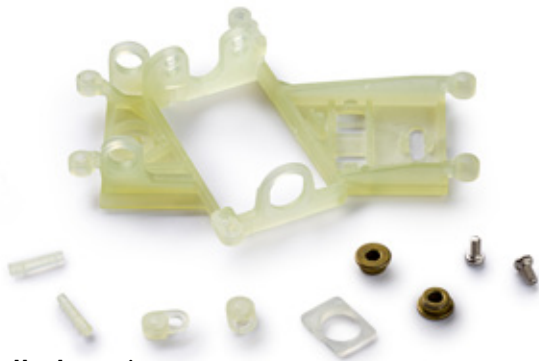

CH119b **Hard** - no pigment

CH119c **Carbon fiber** - black

To be used with CH105 bearing

# Motor mount

## Anglewinder 1.25 Offset

for Boxer / Flat-6 motors



CH123

**Carbon fiber** - black

CH130

**Hard** - orange ■

19



CH124

**Carbon fiber** - black

CH131

**Hard** - orange ■



## Motor mount

Sidewinder 0.5 Offset  
for V12 motor



CH67

**Medium** - grey

**Classic box stock models**

---

## Motor mount

Sidewinder 1.0 Offset  
for V12 motor



CH65

**Medium** - no pigment

**GT3 box stock models**

---

## Motor mount

20 Sidewinder 0.75 Offset  
for V12 motor

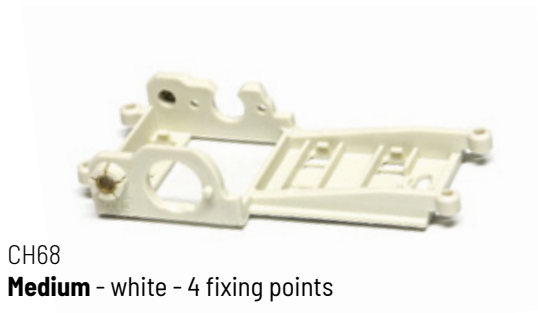

CH68

**Medium** - white - 4 fixing points

---



CH69

**Medium** - white - 6 fixing points

---



CH115b

**Medium** - no pigment

To be used with CH105 bearing

---



21

# Motor mount

Inline 0.0 Offset

for V12 Motor



CH13c

**Medium** - black

---

# Motor mount

Inline 0.0 Offset

for Boxer / Flat-6 Motors



CH48b

**Hard** - black

---

# Inline 0.5 Offset

for V12 Motor



CH110

**Medium** - grey

**Classic DTM and Group C box stock models**

---

# Inline 0.5 Offset

for Boxer / Flat-6 Motors



CH114

**Hard** - grey

---

# Inline 1.0 Offset

for V12 Motor



CH24c

**Medium** - no pigment

---

# Inline 1.0 Offset

for Boxer / Flat-6 Motors

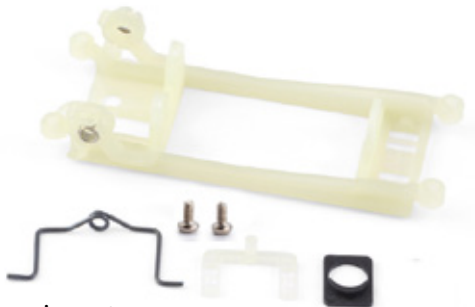

CH49b

**Hard** - no pigment

---



# Motor mounts

## Conversion Kit OFFSET 0.0 mm



KK11  
**Anglewinder** Conversion Kit  
Z30 AW Crowns + Z11 Ø 6.5 mm Pinion

---

# Motor mounts

## Conversion Kit OFFSET 1.0 mm



KK10c  
**Anglewinder** Conversion Kit  
Z30 AW Crowns + Z11 Ø 6.5mm Pinion

---

## Conversion Kit OFFSET 0.5 mm



KK13b  
**Sidewinder** Conversion Kit  
Z34 Ø 18 SW Crowns + Z11 Ø 6.5 mm Pinion

---



KK14d  
**Flat Anglewinder Offset** Conversion Kit  
Z25 Ø15 AW plastic Crown + Z11 Ø 6.5mm Pinion

---

## Conversion Kit OFFSET 1.0 mm



KK12b  
**Sidewinder** Offset Conversion Kit  
Z34 Ø18 SW Crowns + Z11 Ø 6.5mm Pinion

---



KK16b  
**Flat Anglewinder Offset PCR** Conversion Kit  
Z28 Ø15 AW plastic Crown + Z11 Ø 6.5mm Pinion

---



# System



CH107  
**Z16 pulley**  
for magnesium  
wheels

●  
CH99  
**Z16 pulley**  
cyan - (2x)

● ●  
CH100  
**Z17 pulley**  
black - (2x)

● ● ●  
CH101  
**Z18 pulley**  
yellow - (2x)



# System

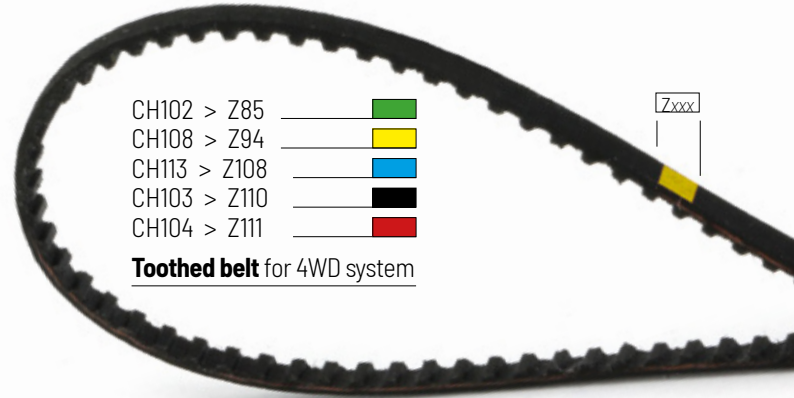

CH102 > Z85 █  
CH108 > Z94 █  
CH113 > Z108 █  
CH103 > Z110 █  
CH104 > Z111 █

Zxxx

**Toothed belt** for 4WD system



PA73as  
**Assembled front plastic 4WD**  
Ø16.5 x 8.2 wheels (2x)

26 PA72as  
**Assembled front plastic 4WD**  
Ø15.8 x 8.2 wheels (2x)

PA74as  
**Assembled front plastic 4WD**  
Ø17.3 x 8.2 wheels (2x)



PA72  
**Front plastic wheels**  
Ø15.8 mm (2x)

PA73  
**Front plastic wheels**  
Ø16.5 mm (2x)

PA74  
**Front plastic wheels**  
Ø17.3 mm (2x)



CH95  
**Hubs for 4WD**  
front wheels (2x)



CH96  
**Bearings for 4WD**  
front wheels (2x)



CH98y  
**Tensioner, flanges and spacers**  
yellow █

CH98  
**Tensioner, flanges and spacers**

CH98c  
**Tensioner, flanges and spacers**  
cyan █

27



CH97  
**Snap rings**  
for 4WD front wheels (10x)



CH94  
**0.08mm spacers**  
for 4WD wheels (6x)

# Motors

**Slot.it** motors are available in three different configurations:

the traditional 'small can' **V12/4** type, the longer **'Boxer'** type, and Slot.it's own **'Flat-6'**.



INLINE

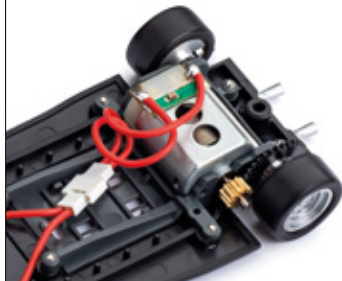

SIDEWINDER

**'Inline'** refers to the motor axle being perpendicular to the rear axle.

**'Sidewinder'** indicates that the motor runs parallel to the rear axle, i.e., transversely.

**'Anglewinder'** is a combination of the above configurations.



ANGLEWINDER



INLINE BOXER

The **FLAT-6** is a custom-built Slot.it motor designed to be compatible with existing Boxer/NC type motor pods while also taking advantage of a lower center of gravity when used in special Slot.it motor pods. Its 'slim' form allows for use in anglewinder configuration under streamlined LMP racers like Slot.it's **Audi R8C**, **Lola LMP**, and **Audi R18 TDI**.

# Motors

The **V12/4** motors feature a double axle, making them a universal motor upgrade for cars from most manufacturers. Additionally, a special 'RX' adapter is available to upgrade cars with an 'RX' motor to a V12 one.

The **'Boxer'** type motors are ideal upgrades for the larger motors found in some slot cars. They can also be used as inline or 'anglewinder'.



Boxer motor mount

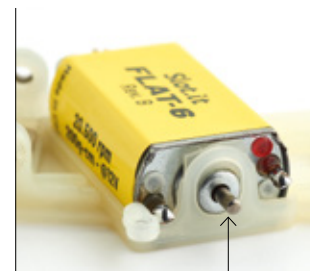

Flat motor mount

All 'small can' motors MX16, MX17, and their variants have the RPM value laser engraved on the side of the metal case, e.g., 21K or 23K.



# Motors Flat-6



MN09CH  
**Flat-6 Classic GT / LMP**  
 Slot.it models box stock  
 20.500 rpm - 200g\*cm @12V

The Flat-6 is a Slot.it proprietary design



30 MN13CH  
**Flat-6S**  
 22.500 rpm - 230g\*cm @12V



MN14H  
**Flat-6RS**  
 25.000 rpm - 240g\*cm @12V - asymmetric case openings

GT RACING



MN11H-2  
**Flat-6R**  
 22.000 rpm - 220g\*cm @12V

High magnetic traction

# Motors Boxer



MN08CH  
**Boxer/2**  
 21.500 rpm - 340g\*cm @12V

The Boxer/2 is the most powerful Slot.it motor.



# Motors V12/4

MX15  
**V12/4 Classic DTM / Touring Cars**  
 Slot.it models box stock  
 21.000 rpm - 150g\*cm @12V

MX16  
**V12/4 Gr.C/Classic**  
 Slot.it models box stock  
 23.000 rpm - 170g\*cm @12V

MX17  
**V12/4**  
 29.000 rpm - 160g\*cm @12V



31

MX16-M  
**V12/4 Classic / Modern GT**  
 Slot.it models box stock  
 23.000 rpm - 170g\*cm @12V



SP08  
**Adaptor V12** to RX shape motor





# Pinions

Ø 5.5 mm - Brass



**Pinion 8 teeth** (2x) \_\_\_\_\_ PI08  
**Pinion 9 teeth** (2x) \_\_\_\_\_ PI09  
**Pinion 10 teeth** (2x) \_\_\_\_\_ PI10  
**Pinion 11 teeth** (2x) \_\_\_\_\_ PI11

**Pinion 8+9+10+11 teeth** (4x) \_\_\_\_\_ PIMX

# Pinions

Ø 6.5 mm - Brass



**Pinion 10 teeth** (2x) \_\_\_\_\_ PS10  
**Pinion 11 teeth** (2x) \_\_\_\_\_ PS11  
**Pinion 12 teeth** (2x) \_\_\_\_\_ PS12  
**Pinion 13 teeth** (2x) \_\_\_\_\_ PS13

**Pinion 10+11+12+13 teeth** (4x) \_\_\_\_\_ PSMX

32 Ø 6 mm - Brass



**Pinion 10 teeth** (2x) \_\_\_\_\_ PI6010o  
**Pinion 11 teeth** (2x) \_\_\_\_\_ PI6011o

Ø 6.75 mm - Brass



**Pinion 11 teeth** (2x) \_\_\_\_\_ PI6711o  
**Pinion 12 teeth** (2x) \_\_\_\_\_ PI6712o

33 Ø 6.5 mm - Ergal



**Pinion 10 teeth** (1x) \_\_\_\_\_ PI6510e  
**Pinion 11 teeth** (1x) \_\_\_\_\_ PI6511e  
**Pinion 12 teeth** (1x) \_\_\_\_\_ PI6512e

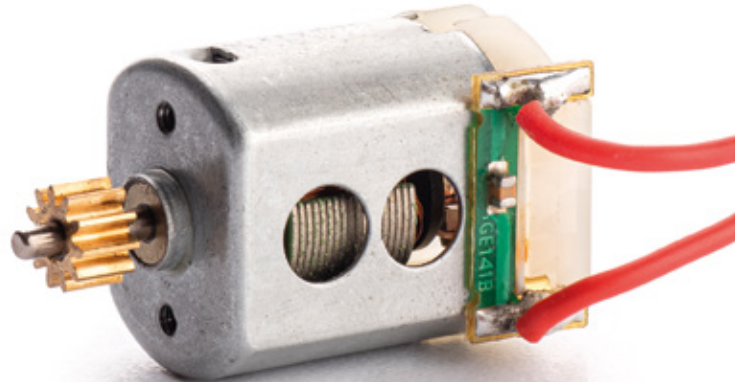

# Pinions

## Ø 7 mm - Ergal



<b>Pinion 12 teeth</b> (1x)	_____	PI7012e
<b>Pinion 13 teeth</b> (1x)	_____	PI7013e
<b>Pinion 14 teeth</b> (1x)	_____	PI7014e

Probably the best pinion in the world:  
0.3 grams only, chemically hardened and Teflon coated

## Ø 5.5 mm - Internal Ø 1.5mm



<b>Pinion 9 teeth</b> (2x)	_____	PI559o15
<b>Pinion 10 teeth</b> (2x)	_____	PI5510o15

## Ø 6 mm - Internal Ø 1.5mm



<b>Pinion 9 teeth</b> (2x)	_____	PI609015
<b>Pinion 10 teeth</b> (2x)	_____	PI6010o15
<b>Pinion 11 teeth</b> (2x)	_____	PI6011o15

# Extractor / Press

The SLOT.IT extractor/press consists of the following components:

Main frame: **[1]** constructed entirely from fiberglass-reinforced plastic. The main screw passes through two co-molded brass threads to prevent wear on the thread itself. The dimensions of the plastic body are designed to accommodate most motors, from common short can motors to less common double long transmission shaft 4WD motors. Counter bushing **[6]**: Made of brass, this bushing must be screwed onto the lower inside part of the main body before using the tool. The counter bushing serves two important functions:

- Centres the double shaft motor perfectly using the axle housing hole.
- Keeps all motors that do not have a double shaft centred and protects the inner bushing of long can motors that do not have an axle stub protruding from the can.

Special steel extraction plate **[5]**: Fits into the relevant housing in the main body to extract the pinions. This plate is highly resistant and features a very thin eyelet located between the motor and the pinion, measuring only 0.7 mm. This allows for the extraction of pinions located very close to the motor case without causing damage. Multifunction brass tool **[2]**: Depending on the operation to be performed, this tool must be inserted into the main body with the plug (steel, interchangeable, Ø1.9mm to avoid damaging the pinion hole) downwards for extraction, or the pinion housing downwards for pressing. The pinion housing for this element is designed to accommodate pinions with a diameter ranging from 5.5mm to 7.5mm without damaging them.

Steel plug **[3]**: Locked into the brass tool by an M3 grub screw **[4]**.

Advancement screw **[7]**: The upper part of this screw features an ergonomic plastic knob **[8]**, while the lower part is designed to couple perfectly with the tool bevel, reduce friction, and allow the press to operate perpendicularly without clearance.



TL01

**Professional Extractor Press**

# Extractor/Press



PRESS THE PINION  
LEAVING MOTOR AND  
CROWN IN PLACE

TL04  
**Professional upgrade kit**  
for extractor press TL01/SP21

36



PULL THE PINION  
LEAVING MOTOR AND  
CROWN  
IN PLACE



TL05b  
**Professional Mini Puller**  
now for up to 7.5mm diameter pinions

37



TL06b  
**Professional extractor press and puller set**

TL08  
**Steel plug**  
ø 1.9 and ø 1.4mm for extractor  
SP21/SP31b/TL01/TL05/TL06 (1+1)



TL02  
**Extraction plate** and counter  
plate spares for TL01/SP21



TL03  
**Multifunction brass tool steel**  
plug and M3 screw for SP21/TL01



TL01  
**Professional extractor press and puller set**

# Sidewinder Spur Gears

M2 HEX

SCREW

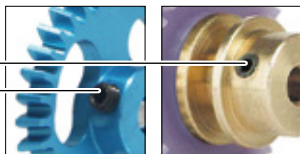

## Ergal light Ø18 mm

<b>31 teeth</b>	silver color	_____	GS1831
<b>32 teeth</b>	black color	_____	GS1832
<b>33 teeth</b>	pink color	_____	GS1833
<b>34 teeth</b>	cyano color	_____	GS1834
<b>35 teeth</b>	gold color	_____	GS1835
<b>36 teeth</b>	violet color	_____	GS1836



## Aluminium + light plastic Ø18 mm

<b>31 teeth</b>	white color	_____	GS1831-LPL
<b>32 teeth</b>	black color	_____	GS1832-LPL
<b>33 teeth</b>	pink color	_____	GS1833-LPL
<b>34 teeth</b>	cyano color	_____	GS1834-LPL
<b>35 teeth</b>	yellow color	_____	GS1835-LPL
<b>36 teeth</b>	violet color	_____	GS1836-LPL

# Sidewinder Spur Gears



## Ergal light Ø19 mm

<b>34 teeth</b>	cyano color	_____	GS1934
<b>36 teeth</b>	violet color	_____	GS1936
<b>38 teeth</b>	green color	_____	GS1938

# Inline Offset Modular Crowns



## Aluminium

<b>23 teeth</b>	Ø13,8 mm plastic external diameter	_____	GM23o
<b>24 teeth</b>	Ø14,4 mm plastic external diameter	_____	GM24o
<b>25 teeth</b>	Ø14,8 mm plastic external diameter	_____	GM25o
<b>26 teeth</b>	Ø15,3 mm plastic external diameter	_____	GM26o
<b>27 teeth</b>	Ø15,8 mm plastic external diameter	_____	GM27o
<b>28 teeth</b>	Ø16,3 mm plastic external diameter	_____	GM28o
<b>29 teeth</b>	Ø16,8 mm plastic external diameter	_____	GM29o
<b>30 teeth</b>	Ø17,3 mm plastic external diameter	_____	GM30o



# Inline Modular Crowns



## Aluminium

<b>23 teeth</b> pink color	_____	GM23i
<b>24 teeth</b> green color	_____	GM24i
<b>25 teeth</b> orange color	_____	GM25i
<b>26 teeth</b> blue color	_____	GM26i
<b>27 teeth</b> black color	_____	GM27i
<b>28 teeth</b> yellow color	_____	GM28i
<b>29 teeth</b> violet color	_____	GM29i
<b>30 teeth</b> red color	_____	GM30i

40

# Inline Crown Gears



41

# Modular Crowns



<b>Ferrule</b> for Ø5,5mm pinions	_____	GMF55
<b>Ferrule</b> for Ø6mm pinions	_____	GMF60

## Bronze / Aluminium + teflon

<b>23 teeth</b> pink color	_____	G123-bz / G123-al
<b>24 teeth</b> green color	_____	G124-bz / G124-al
<b>25 teeth</b> orange color	_____	G125-bz / G125-al
<b>26 teeth</b> blue color	_____	G126-bz / G126-al
<b>27 teeth</b> black color	_____	G127-bz / G127-al
<b>28 teeth</b> yellow color	_____	G128-bz / G128-al
<b>29 teeth</b> violet color	_____	G129-bz / G129-al
<b>30 teeth</b> red color	_____	G130-bz / G130-al

**Set 24-26-27-28-30 teeth** - Bronze insert

G1X1

# Inline Offset Crown Gears



## Bronze / Aluminium + teflon

- 23 teeth** Ø13,8 mm plastic external diameter — G023-bz / G023-al
- 24 teeth** Ø14,4 mm plastic external diameter — G024-bz / G024-al
- 25 teeth** Ø14,8 mm plastic external diameter — G025-bz / G025-al
- 26 teeth** Ø15,3 mm plastic external diameter — G026-bz / G026-al
- 27 teeth** Ø15,8 mm plastic external diameter — G027-bz / G027-al
- 28 teeth** Ø16,3 mm plastic external diameter — G028-bz / G028-al
- 29 teeth** Ø16,8 mm plastic external diameter — G029-bz / G029-al
- 30 teeth** Ø17,3 mm plastic external diameter — G030-bz / G030-al

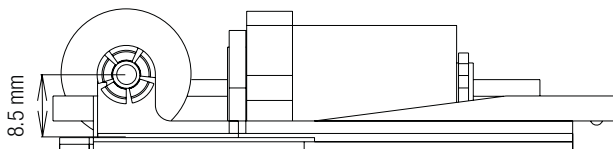

FOR OFFSET MOTOR MOUNT CH24c - CH49b

# Anglewinder Gears Ergal Anglewinder Gears



## Ergal light Ø16 mm

- 26 teeth** cyano color \_\_\_\_\_ GA1626e
- 27 teeth** black color \_\_\_\_\_ GA1627e
- 28 teeth** gold color \_\_\_\_\_ GA1628e
- 29 teeth** violet color \_\_\_\_\_ GA1629e
- 30 teeth** red color \_\_\_\_\_ GA1630e
- 31 teeth** silver color \_\_\_\_\_ GA1631e



## Ergal light Ø18 mm

- 32 teeth** black color \_\_\_\_\_ GA1832e
- 33 teeth** pink color \_\_\_\_\_ GA1833e
- 34 teeth** cyano color \_\_\_\_\_ GA1834e
- 35 teeth** gold color \_\_\_\_\_ GA1835e
- 36 teeth** violet color \_\_\_\_\_ GA1836e



# Starter Kit

KK01b  
**Kit inline**  
Z28 crown  
15.8x8.2x1.5mm wheels



KK07c  
**Kit inline**  
Z28 crown  
17.3x9.75x1.5mm wheels  
+ 1mm spacers



46 KK08b  
**Kit inline**  
Z27 crown  
15.8x8.2x2.5mm plastic wheels

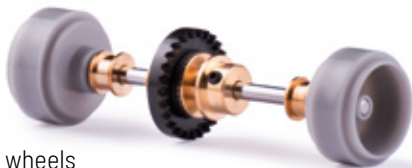

OLD CARRERA

KK03c  
**Kit inline**  
Z26 crown + Z9 pinion  
17.3x9.75x1.5mm wheels  
+ 1mm spacers



CARRERA DTM

KK17  
**Kit inline**  
Z26 crown  
17.3x8.2mm wheels



# Starter Kit

KK02b  
**Kit sidewinder**  
Z36 Ø19 crown  
15.8x8.2x1.5mm wheels  
+ 1mm spacers



KK04c  
**Kit sidewinder**  
Z36 Ø19 crown  
17.3x9.75x1.5mm wheels  
+ 1mm spacers



KK05b  
**Kit sidewinder**  
Z34 Ø18 crown  
15.8x8.2x1.5mm wheels  
+ 1mm spacers



KK15b  
**Kit sidewinder**  
Z36 Ø19 crown  
17.3x8.2x1.5mm wheels  
+ 1mm spacers



FOR NINCO

KK09d  
**Kit anglewinder**  
Z32 crown + Z12 pinion  
17.3x9.75x1.5mm wheels



KK18  
**Upgrade kit**  
for vintage  
Policar cars





# Wheels

∅ 14.3 x 8 mm

W14308015A ex PA33-Als

Al ∅14.3 x 8 x 1.5mm

**wheels**, M2 grub - 1.2g (2x)



W14308015P ex WH1215-PI

PI ∅14.3 x 8 x 1.5mm

**wheels**, 0.59g (4x)



∅ 15.8 x 8.2 mm

W15808225A ex WH1050-Al

Al ∅15.8 x 8.2 x 2.5mm

**wheels**, M2 grub - 1.4g (2x)



W15808215A ex PA24-Als

Al ∅15.8 x 8.2 x 1.5mm

**wheels**, M2 grub - 1.4g (2x)



W15808215Ma ex WH1183-Mg

Mg ∅15.8 x 8.2 x 1.5mm

**hollow wheels**, M2 grub, 0.8g (2x)



W15808215AF ex PA24-Alf

Al ∅15.8 x 8.2 x 1.5mm

**wheels double shoulder**

M2 grub - 1.1g (2x)



W15808225M ex PA17-Mg

Mg ∅15.8x8.2x2.5mm

**wheels**, M2 grub - 0.9g (2x)



W15808215AH ex PA24-Alh

Al ∅15.8 x 8.2 x 1.5mm

**wheels double shoulder**

holed channel M2 grub - 1g (2x)



# Wheels

∅ 15.8 x 8.2 mm

W15808225P ex PA17-PI

PI ∅15.8x8.2x2.5mm

**wheels** 0.71g (4x)



W15808215P ex WH1210-PI

PI ∅15.8x8.2x1.5mm

**wheels** 0.7g (4x)



W15808205P

PI ∅15.8x8.2x0.5mm

**wheels** 0.7g (4x)



W15808215-3D

3D ∅15.8x8.2x1.5mm

**wheels**, (2x)



∅ 15.8 x 10.2 mm

W15810215AF ex PA49-Alf

Al ∅15.8 x 10.2 x 1.5mm

**wheels**, double shoulder,

M2 grub - 1.3g (2x)



W15810215AH ex PA49-Alh

Al ∅15.8 x 10.2 x 1.5mm

**wheels, double shoulder**

holed channel, M2 grub - 1.2g (2x)



W15810215M ex WH1184-Mg

Mg ∅15.8 x 10.2 x 1.5mm

**hollow wheels**, M2 grub, 0.9g (2x)



# Wheels

∅ 16.5 x 8.2 mm

W16508215A ex PA43-Als

Al ∅16.5 x 8.2 x 1.5mm

**wheels**, M2 grub, 1.5g (2x)



W16508215Ma ex WH1185-Mg

Mg ∅16.5 x 8.2 x 1.5mm

**hollow wheels**, M2 grub, 0.75g (2x)



W16508215-3D

3D ∅16.5x8.2x1.5mm

**wheels**, (2x)



W16508225P ex PA43-PI

PI ∅16.5 x 8.2 x 2.5mm

**wheels**, 0.76g - (4x)



50 ∅ 16.5 x 10.2 mm

W16510215M ex WH1186-Mg

Mg ∅16.5 x 10.2 x 1.5mm

**hollow wheels**, M2 grub, 0.9g (2x)



∅ 16.9 x 8.2 mm

W16908215M ex WH1288-Mg

Mg ∅16.9 x 8.2 x 1.5mm

**hollow wheels**, M2 grub, 0.78g (2x)



∅ 16.9 x 9.75 mm

W16909715Ma

PI ∅16.9 x 9.75 x 1.5mm

**hollow wheels**,

M2 grub, 0.85g (2x)



∅ 17.3 x 8.2 mm

W17308225A ex WH1048-Al

Al ∅17.3 x 8.2 x 2.5mm

**wheels**, M2 grub, 1.6g (2x)



# Wheels

∅ 17.3 x 8.2 mm

W17308215A ex WH1110-Al

Al ∅17.3 x 8.2 x 1.5mm

**wheels**, M2 grub, 1.6g (2x)



W17308215M ex WH1230-Mg

Mg ∅17.3 x 8.2 x 1.5mm

**hollow wheels**, M2 grub, 0.8g (2x)



W17308205P ex WH1254-PI

PI ∅17.3 x 8.2 x 0.5mm

**wheels**, 0.75g (4x)



W17308215P

PI ∅17.3 x 8.2 x 1.5mm

**wheels**, 0.72g (4x)



W17308225P ex WH1071-PI

PI ∅17.3 x 8.2 x 2.5mm

**wheels**, 0.8g (4x)



W17308215-3D

3D ∅17.3x8.2x1.5mm

**wheels**, (2x)



∅ 17.3 x 9.75 mm

W17309715A ex PA62-Als

Al ∅17.3 x 9.75 x 1.5mm

**wheels**, M2 grub, 1.6g (2x)



W17309715Ma ex WH1231-Al

Mg ∅17.3x9.75x1.5mm

**hollow wheels**, M2 grub, 0.9g (2x)



# Wheels

Ø 17.3 x 10 mm

W17310005P ex WH1179-PI  
PI Ø17.3 x 10 x 0.5mm  
**wheels**, 0.85g (4x)



## For Sponge Tyres

Compatible with Slot.it wheel inserts

W13609515A ex WH1211-AI  
Ø13.6 x 9.5 x 1.5mm  
**wheels** equivalent Ø15.8mm  
M2 grub (2x)



W14209515A ex WH1190-AI  
Ø14.2 x 9.5 x 1.5mm  
**wheels** equivalent Ø16.5mm  
M2 grub (2x)



W15009515A ex WH1212-AI  
Ø15.0 x 9.5 x 1.5mm  
**wheels** equivalent Ø17.3mm  
M2 grub (2x)



PT1209SP25  
SP25 compound  
**Sponge tyres**  
dwg 1209 (4x)



PT1209SP30  
SP30 compound  
**Sponge tyres**  
dwg 1209 (4x)

# Axle and Spacer

PA01-45  
PA01-48  
PA01-51  
PA01-54

**Steel ProAxle** turned ground, polished - 2.38 mm (3/32") (2x)



PA01-51H  
PA01-54H  
PA01-58H

**Steel ProAxle** turned ground, polished, hollow - 2.38 mm (3/32") (2x)



PA01-48R  
PA01-51R  
PA01-54R

Reduced center diameter

**Steel ProAxle** polished - 2.38 mm (3/32") for sidewinder (2x)



PA39  
Independent front wheels axle



PA57  
**Light Stopper** for anglewinder  
setup Aluminium (2x)



PA25  
**Stopper** for anglewinder  
setup Aluminium+teflon (1x)



PA51  
**Set of spacers**  
for hubs 1mm thick (x10)



PA52  
**Set of spacers**  
for hubs and bushings  
0.6mm thick



PA47  
**Set of spacers**  
for hubs and bushings  
0.1 / 0.25mm thick

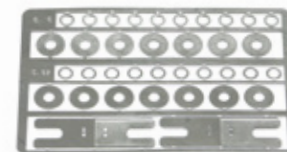

# Plastic inserts

(for Ø15.8mm and for Ø16.5mm wheels)



PA55

## Plastic inserts BBS '80s

for Ø15.8mm (4x) Ø16.5mm (2x) wheels - Porsche 956/962 type



PA53

## Plastic inserts

for Ø15.8mm (4x) Ø16.5mm (2x) wheels Lancia LC2-85 type



PA48

## Plastic inserts

for Ø15.8mm (4x) Ø16.5mm (2x) wheels Toyota 88C type



PA65

## Plastic inserts

for Ø15.8mm (2x) Ø16.5mm (2x) wheels Nissan R89C type



PA44

## Plastic inserts

for Ø15.8mm wheels (4x) - Mazda 787B type



PA30

## Plastic inserts

for Ø15.8mm wheels (4x) - Sauber C9 type

# Plastic inserts

(for Ø15.8mm and for Ø16.5mm wheels)



PA31

## Plastic inserts

for Ø15.8mm wheels (4x) - Jaguar XJR type



PA34

## Plastic inserts

for Ø15.8mm wheels (4x) - Lancia LC2-84 type



PA87

## Plastic inserts

for Ø15,8mm wheels (4x) - Mazda 767B

54

55

Wheel inserts type may be different

Wheel inserts type may be different



# Plastic inserts

## Modern GT/LMP

(for Ø17.3mm wheels)

PA60

### Plastic inserts BBS

for Ø17.3mm wheels (4x)

Porsche 911 GT1 - Lola B09 B10 B11 - Aston Martin type



PA79

### Plastic inserts OZ

for Ø17.3mm wheels (4x) - Maserati GT3



PA70

### Plastic inserts OZ

for Ø17.3mm wheels (4x) - 11 spokes



PA82

### Plastic inserts RAYS

for Ø17.3mm wheels - Nissan GT-R Nismo GT3



PA84

### Plastic inserts

for Ø17.3mm wheels (4x)



PA85

### Plastic inserts

for Ø17.3mm wheels (4x)



# Plastic inserts

## Classic '70s

(for Ø14.3mm and for Ø15.8mm wheels)

PA63p

### Plastic inserts

for Ø15.8mm wheels (4x) - McLaren M8D type



PA64

### Plastic inserts

for Ø15.8mm wheels (4x)

Matra-Simca MS670B type



PA41

### Plastic inserts

for Ø15.8mm (4x) Ø14.3mm (2x) wheels Alfa Romeo 33/3 type



PA45

### Plastic inserts

for Ø15.8mm wheels (4x) - Chaparral 2E type



PA46

### Plastic inserts

for Ø15.8mm wheels - (4+4) - Ford GT40 type



PA83

### Plastic inserts

for Ø15.8mm wheels (4x) - 512M



# Plastic inserts

## Classic '70s

(for Ø14.3mm and for Ø15.8mm wheels)



PA86

### Plastic inserts 0Z

for Ø15.8mm wheels (4x) - Datsun 510

## Classic DTM (for Ø15.8mm wheels)

58



PA71

### Plastic inserts Speedline

for Ø15.8mm wheels (4+2)



PA75

### Plastic inserts 0Z

for Ø15.8mm wheels (4+2)



PA77

### Plastic inserts BBS type

for Ø15.8mm wheels (4+2)

# Plastic inserts

## Classic DTM (for Ø15.8mm wheels)



PA78

### Plastic inserts 0Z

for Ø15.8mm wheels (4+2)



PA80

### Plastic inserts

RAYS type 5 spoke for Ø15.8/16.5mm wheels



PA81

### Plastic inserts

RAYS type 6 spoke for Ø15.8/16.5mm wheels

## Modern GT/LMP

(for Ø15.8mm wheels)



- **black** Plastic inserts BBS for Ø15.8mm wheels \_\_\_\_\_ PA03b
- **silver** Plastic inserts BBS for Ø15.8mm wheels \_\_\_\_\_ PA03s
- **gold** Plastic inserts BBS for Ø15.8mm wheels \_\_\_\_\_ PA03g

# Tyres

Slot.it provides a comprehensive range of tires for the racer and the scale modeler alike.



PT19 > **Z1** - 8x14.2 (4x)  
dwg 1096 - Low profile slick

PT1214S2 > **S2** - 8.4x14.6 (4x)  
dwg 1214 - Low profile slick

PT1088C1 > **C1**  
dwg 1088 - slick 8x16.1 (4x)

PT1159C1 > **C1**  
dwg 1159 - slick 9.5x17.2 (4x)

PT1228C1 > **C1**  
dwg 1228 - slick 9.5x17.8 (4x)

PT1140C1 > **C1**  
dwg 1140 - slick 9.5x19.8 (4x)

PT15 > **Z0** - 10x16.5 (4x)  
dwg 1067 - Low profile slick

PT1167C1 > **C1** PT1167S2 > **S2**  
dwg 1167 - slick 10x17.8 (4x)

PT1207P6B > **P6B** PT1207G25 > **G25**  
PT1207F22 > **F22** dwg 1207 - slick 10x18 (4x)

PT1323C1 > **C1** PT1323G25 > **G25** PT1323F22 > **F22**  
dwg 1323 - slick 10.6x20.2 (4x)

PT1027P6B > **P6B**  
PT06 > **S1** PT07 > **Z0**  
dwg 1027 - slick 10x18.8 (4x)

PT1171G25 > **G25** PT1171F22 > **F22**  
dwg 1171 - slick 10x19.5 (4x)

PT1121C1 > **C1**  
dwg 1121 - slick 10x19.5 (2x)

PT1120C1 > **C1**  
dwg 1120 - slick 10.5x20 (2x)

PT1152C1 > **C1**  
dwg 1152 - slick 10.5x19 (4x)

PT1172G25 > **G25** PT1172F22 > **F22**  
dwg 1172 - slick 11.3x20 (4x)

PT1028P6B > **P6B** PT03 > **S1**  
dwg 1028 - 12.2x19.8 - (4x)

PT16 > **S1** PT23 > **P5** PT29 > **F22**  
dwg 1068 - F1 12.4x20.4 - (4x)

## DIMENSION OF TYRE AFTER ASSEMBLY ON WHEEL

60

### REFERENCE BY TRACK - COMPOUND - TYRES CODE

Suggested use >	Ninco	Carrera	Front wheels only					Policar	Any	Scalextric Sport	Smooth and clean surface		
Compound >	P5	P6	Z0	Z1	S2	G25	F22	P6B	SP30	C1	S1	S2	
Reference Code >	PT23	PT25	PT107 PT15	PT19	PT1214S2	PT1207G25 PT1171G25 PT1172G25 PT1323G25	PT29 PT1171F22 PT1207F22 PT1323F22 PT1172F22	PT1207SP6B PT1027SP6B PT1028SP6B	PT1208SP30	PT1152C1 PT1159C1 PT1167C1 PT1088C1 PT1228C1 PT1323C1 PT1140C1 PT1120C1 PT1121C1	PT03 PT06 PT16	PT1167S2	

■ = box stock

### SPONGE TYRES

Compound	SP30 / SP25
Code	PT1209SP30 / PT1209SP25
dwg	1209
Tyres dimension (mm)	9.5 x 19.5

### WHEELS FOR SPONGE TIRES (9.5 mm)

Code	Diameter	Equivalence
W13609515A	13.0	15.8
W14209515A	14.2	16.5
W15009515A	15.0	17.0

61

### REFERENCE BY WHEELS DIMENSION - TYRES CODE/DWG

WHEELS dim.(mm)	PT19	PT1214S2	PT1088C1	PT1159C1	PT1228C1	PT1140C1	PT15	PT1167C1 PT1167S2	PT1207F22 PT1207N22 PT1207G25 PT1207P6B	PT1027P6B PT06 PT07	PT1171F22 PT1171G25	PT1121C1	PT1152C1	PT1120C1	PT1323F22 PT1323C1 PT1323G25	PT1172F22 PT1172G25	PT1028P6B PT25 PT03	PT16 PT23 PT29
	14.3	15.1	15.1	17	x	x	x	x	x	x	x	x	x	x	x	x	x	x
15.8	16.7	16.7	18.4	18.3	19.8	20.1	17	19.1	19.6	19	19.7	19.4	19	19.9	20.2	19.9	19.7	x
16.5	17.3	17.3	19	18.9	20.3	20.6	17.6	19.6	20.2	19.6	20.3	20	19.6	20.5	21	20.4	20.3	x
16.9	17.6	17.6	19.3	19.2	20.6	20.9	17.9	19.9	20.5	19.9	20.6	20.3	19.9	20.8	21.3	20.7	20.6	x
17.3	18.1	18.1	19.7	19.4	21	21.3	18.3	20.3	20.8	20.2	21	20.7	20.3	21.2	21.4	21.1	21	x
dwg	1096	1214	1088	1159	1228	1140	1067	1167	1207	1027	1171	1121	1152	1120	1323	1172	1028	1068
Tyres dimension (mm)	8 x 14.2	8.4 x 14.6	8 x 16.1	9.5 x 17.2	9.5 x 17.8	9.5 x 19.8	10 x 16.5	10 x 17.8	10 x 18	10 x 18.8	10 x 19.5	10 x 19.5	10.5 x 19	10.5 x 20	10.6x20.2	11.3 x 20	12.2 x 19.8	12.4 x 20.4

# Bushings & Pulleys

CH105

**Flanged bearings** for CH118 - CH119 - CH115 - CH117 and for Policar F1(2x)



CH14

**Bronze spherical bushings** (6x)



PA02

**Bronze bushings** (2x)



PA32

**Aluminium bushings** Aluminium+Teflon (2x)



PA12

**Brass bushings** old Carrera (2x)



PA11

**Bronze bushings** for Proslot (2x)



PA68

**Brass bushings** for Carrera and Scalextric (4x)



62

CH56b

**Bronze spherical bushings**  
Standard Slot.it models (6x)



# Magnet

CN01

**Neodimium magnet** 25x8x2mm for Scalextric



CN02

**Neodimium C shaped magnet** 25x8x2.3mm for Scalextric



CN06

**Neodimium standard magnet** for motor mounts



CN07

**Neodimium race magnet** for motor mounts



# Ballast

SP23

**Tungsten ballast** motor mount shape 2.5g (1x)



SP25

**Tungsten ballast putty** 10g (1x)



SP24

**Tungsten ballast cylinder** 6.3x1mm, 0.58g (6x)



# Suspensions



CH47c

**Spring suspension kit** - for all type of motor mounts

CH127

**Fiberglass suspension bar**  
for CH47c (2x + 2x)



CH09

**Magnetic suspension kit**



CN08 - Ø 4x1mm (8x)

CN09 - Ø 4x1.5mm (8x)

CN10 - Ø6x1.5mm (8x)

CN12 - Ø6x1.5mm (8x) - increased magnetism

**Neodimium magnet** for magnetic suspension kit



CH77

**Aluminium anodized end of run nuts** (4x)



# Spings For CH47c Suspension

CH55A

**Soft springs** (8x)



CH55B

**Medium springs** (8x)



CH55C

**Ultra soft springs** (8x)



CH55D

**Short ultra soft springs** (8x)



63



# Screwdrivers



PA76  
**Adjustable torque hex**  
M2 screwdriver



PA67c  
**Adjustable torque Torx**  
T3 screwdriver



PA67b  
**Adjustable torque hex**  
M2.5 screwdriver



PA06  
**Hexagonal wrench**  
M2

# Screws

PA58  
**Hexagonal screws**  
M2 x 2mm (10x)



PA40  
**Hexagonal screws**  
M2 x 3mm (10x)



PA37  
**Hexagonal screws**  
for front axle setup  
M2 x 6mm (10x)



PA50  
**Hexagonal screws**  
M2 x 8mm (10x)



PA54  
**Hexagonal screws**  
M2 x 10mm (10x)



PA66  
**Torx screws**  
T3 x 3mm (10x)



CH54b  
**Metric screws**  
chamfered large head  
2.2 x 5.3 mm (10x)



CH128  
**Pickup screws**  
with washer (5x)



CH89  
**Metric screws**  
brass M2.5x6mm  
for Carrera (10x)



CH41c  
**Replacement motor**  
fixing screws (10x)



# Screws

CH51  
**Metric screws** 2.2 x 8mm  
small head (10x). Use for body  
or in conjunction with CH72



CH52  
**Metric screws**  
2.2x8mm big head (10x)



CH53  
**Metric screws**  
2.2x5.3mm small head (10x)



CH54  
**Metric screws**  
2.2x5.3mm big head (10x)



CH120  
**Body to chassis**  
fixing screws (10x)



CH106  
**Set of screws**  
for motor mount (8x)



CH121  
**M2 hexagonal nuts** (10x)



CH122  
**Washers** for M2 screws (20x)



CH125  
**Metric screws**  
chamfered large head  
for suspensions L9 mm (10x)



CH126  
**Metric screws**  
chamfered large head  
for suspensions L13 mm (10x)



CH129  
**Metric screws**  
chamfered large head for  
suspension L11mm (10x)



CH90  
**Motor fixing screws**  
M2 x 4 mm titanium (4x)



# Cars spare parts

\* from CA09e onwards

	MODEL	CODE	CHASSIS	SPARE PARTS	TRANSPARENT PARTS	COCKPITS		WHITE KIT	BODY KIT
						POLYCARBONATE	PLASTIC		
CLASSIC DTM / TOURING CARS	Alfa Romeo 155 V6 TI (1993/94)	CA35	CS35t-60	CS35p	CS35v / CS35vlx	CS35lx		CA35z	CS35b
	Alfa Romeo 155 V6 TI (1995)	CA40	CS40t-60	CS35p / CS40p	CS35v / CS35vlx	CS35lx		CA40z	CS50b
	Alfa Romeo 155 V6 TI (1994/95)	CA50	CS50t-60	CS35p / CS40p	CS35v / CS35vlx	CS35lx			CS50b
	Alfa Romeo 155 V6 TI (1996)	CA45	CS45t-60	CS35p / CS40p	CS35v / CS35vlx	CS35lx		CA45z	
	Datsun 510	CA59	CS59t	CS59p	CS59v	CS59lx		CA59z	CS59b
	Mercedes 190E	CA44	CS44t1	CS44p	CS44v	CS44lx		CA44z1	CS44b1
	Mercede C-Class (1994/95)	CA53	CS53t	CS53p	CS53v	CS53lx		CA53z	CS53b
	Mercedes C-Class (1995/96)	CA54	CS54t	CS53p	CS53v	CS53lx		CA54z	CS53b
	Nissan Skyline GT-R R32	CA47	CS47t	CS47p	CS47v	CS47lx		CA47z	CS47b
	Opel Calibra V6	CA36	CS36t-60 / CS36t-60b	CS36p	CS36v	CS36lx		CA36z1	CS36b
GROUP C	Jaguar XJR12	CA13		CS07p	CS07v	CS07lx	CH87		CS13b
	Jaguar XJR6/9	CA07		CS07p	CS07v	CS07lx	CH87		CS07b
	Jaguar XJR10	CA42	CS42t-60	CS42p	CS42v	CS07lx		CA42z	CS42b
	Jaguar XJR11	CA62	CS42t-60	CS62p	CS42v	CS07lx		CA62z	CA62b
	Lancia LC2-84	CA08	CS08t-60b	CS08p	CS08v	CS08il			
	Lancia LC2-85	CA21	CS08t-60b	CS21p	CS21v	CS08il		CA21z1	
	Mazda 787B	CA15		CS15pp		CS15lx			CS15b
	Mazda 767B	CA60	CS60t-60	CS60p	CS60v	CS60lx		CA60z	CS60b
	Nissan R89C	CA28	CS28t-60	CS28p	CS28v	CS28lx	CA28Z	CA28z	CS28b
	Porsche 956C KH	CA09	CS02t-60c*	CS02p3	CS02v1	CS02lx	CH81b	CA09z1	CS09b1
	Porsche 956C LH	CA02	CS02t-60c	CS02p3	CS02v1	CS02lx	CH81b	CA02z1	CS02b1
	Porsche 962 IMSA	CA25	CS03t-60d	CS02p3	CS02v1	CS02lx	CH81b	CA25z	
	Porsche 962C	CA52	CS03t-60d	CS02p3	CS02v1	CS02lx	CH81b	CA52z	CS52b
	Porsche 962C 85	CA34	CS03t-60d	CS02p3	CS02v1	CS02lx	CH81b	CA34z	CS34b
	Porsche 962C KH	CA17	CS03t-60d	CS02p3	CS02v1	CS02lx	CH81b		CS17b1
	Porsche 962C LH	CA03	CS03t-60d	CS02p3	CS02v1	CS02lx	CH81b	CA03z1	CS03b1
	Sauber C9	CA06				CS05lx			
	Toyota 88C	CA19	CS19t-60c	CS19p	CS19v	CS19il	CH92	CA19z	CS19b
Toyota 86C	CA41	CS19t-60c	CS41p	CS19v	CS19il	CH92	CA41z		

# Cars spare parts

\* and next models

	MODEL	CODE	CHASSIS	SPARE PARTS	TRANSPARENT PARTS	COCKPITS		WHITE KIT	BODY KIT
						POLYCARBONATE	PLASTIC		
CLASSIC	Alfa Romeo Tipo 33/3	CA11	CS11t-60b	CS11p	CS11v		CH58	CA11z1	CS11b1
	Chaparral 2E	CA16	CS16t-60	CS16p3 / CH71 / CH71lx	CS16v		CH78	CA16z1	CS16b1
	Chaparral 2F	CA46	CS46t-60	CS46p / CH71 / CH71lx	CS46v	CS46lx		CA46z	CS46b
	Ferrari 512M	CA51	CS51t-60	CS51p	CS51v	CS51lx		CA51z	CS51b
	Ford GT40	CA18	CS18t-60b	CS18p	CS18v	CS18lx		CA18z1	CS18b
	Ford MKII	CA20	CS18t-60b	CS20p	CS20v	CS18lx		CA20z1	CS20b
	Matra MS 670 B (1973)	CA37	CS27t-60b	CS37p	CS37v			CA37z	CS37b
	Matra MS 670 B (1974)	CA27	CS27t-60b	CS27p	CS27v			CA27z	CS27b
	Matra MS 670 B short tail	CA57	CS57t-60	CS57p	CS57v			CA57z	CS57b
	Matra MS 670 B long tail	CA67	CS57t-60	CS67p	CS57v			CA67z	CA67b
	McLaren M8D	CA26	CS26t-60	CS26p	CS26v			CA26z	CS26b
GT	McLaren F1 GTR	CA10				CS10il	CH86		
	Nissan R390 GT1	CA04/05		CS04p	CS04v	CS04lx			CS14b
	Nissan R390 GT1 Long Tail	CA14		CS04p	CS04v	CS04lx			CS14b
	Porsche 911 GT1 EV098	CA23	CS23t-60			CS23lx			
LMP	Acura ARX-05	CA56	CS55t-60	CS56p / CS56p-soft	CS56v	CS55lx / CS55plx		CS56z	CS56b
	Audi R18 e-tron quattro	CA29	CS24t-60c	CS29p	CS29v	CS24lx	CH91		CS29b
	Audi R18 TDI	CA24	CS24t2-60c CS24t2-60-3D	CS24p	CS24v	CS24lx	CH91		CS24b1 / CS24b2
	Audi R18 Ultra	CA38	CS24t-60c	CS24p / CS29p	CS29v	CS24lx	CH91		
	Audi R8 LMP 2000	CA33	CS33t-60b	CS33p	CS33v			CS33z1	CS33b
	Audi R8C	CA01	CS01t-2	CS01p	CS01v	CS12il			
	Audi R8C Reloaded	CA12	CS12t-60	CS12p	CS12v	CS12il			
	Lola Aston Martin DBR1-2	CA31	CS31t-60c CS31t2-60-3D	CS31p	CS31v	CS22lx	CH93	CA31z1 / CA31z2	CS31b1 / CS31b2
	Lola B09/60, B10/60, B11/80, B12/69 EV	CA22	CS22t-60c CS22t1-60-3D CS22t2-60-3D	CS22p	CS22v	CS22lx	CH93		CS22b1 / CS22b2
	Lola B12/80	CA39	CS22t-60c	CS22p	CS39v/CS22v	CS22lx	CH93	CA39z -CA39z1	CS39b1 / CS39b2
Oreca 07	CA55	CS55t-60 CS55t2-60-3D	CS55p CS55p-soft	CS55v	CS55lx CS55plx		CS55z	CS55b	
MODERN GT	Audi R8 GT3	CA58	CS58t-60	CS58p	CS58v	CS58lx		CS58z	CS58b
	Maserati GT3	CA43	CS43t-60	CS43p	CS43v	CS43lx		CA43z	CS43b
	Maserati GT4	CA48	CS48t	CS43p	CS43v	CS43lx			CS48b
	Nissan GT-R NISMO GT3	CA49a-b	CS49t-60	CS49p	CS49v	CS49lx		CA49z	
	Nissan GT-R NISMO GT3	CA49d*	CS49t-60b	CS49p	CS49v	CS49lx		CA49z1	CS49b



## Slot.it & Policar Official

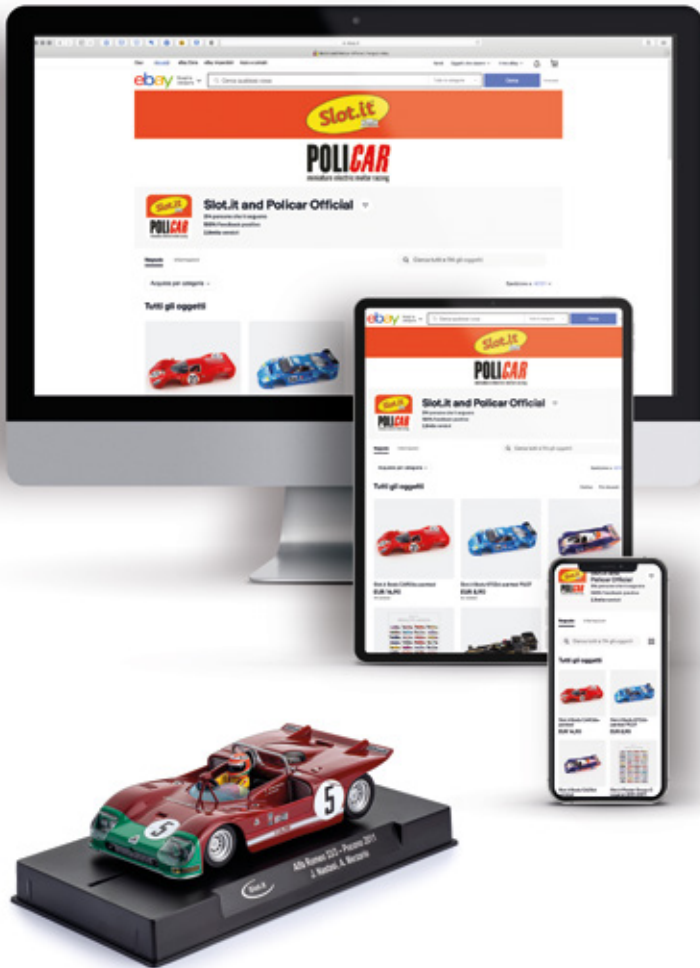

Add to cart



# OXIGEN SLOT RACING DIGITAL SYSTEM

### the right choice for the hobbyist

2.4GHz Wireless, supporting 20 cars per track, capable of accommodating up to 2 tracks within the same radio frequency range: oXigen, derived from the Catalan word for "oxygen," is the Slot.it digital slot racing system designed to handle up to 20 cars simultaneously on an unlimited number of lanes. oXigen boasts unparalleled features, range, and reliability honed over more than a decade of continuous refinement and innovation. Embraced by thousands of passionate racers worldwide, oXigen may be installed on circuits of all sizes, from carpet home setups to grand international 24-hour endurance races. Its versatility knows no bounds, seamlessly integrating with any track configuration. Additionally, oXigen-equipped cars can effortlessly transition to analog traditional tracks and even function as autonomous self-driving vehicles.

## oXigen: just like analog

Ask any racer: driving an oXigen car feels just like driving a standard analog car. Why? **Because only the power comes from the rails, leaving the control signals to the 2.4GHz radio link.** Think about an RC car, powered from the slot track rails. No more 'delayed trigger' feeling so common on other systems! Additionally, oXigen does not require a dedicated power base, eliminating the need for extensive changes to the track power infrastructure.

## Main features

- iOS and Android APP
- Chrono2 Racing Management System with full racing simulation
- Selective Lane Changing
- No dedicated power base, runs on standard analog tracks (with lane changers and finish line magnet markers)
- Compatible with SSD lane changers
- Native oXigen Policar lane changer



70

71



OXIGEN  
AND  
ARC  
READY



SCP301a  
**SCP3 Electronic Wireless Controller**  
integrated oXigen cartridge



SCP301c  
**SCP3 power supply cartridge**  
for SCP3 controller



SCP301b  
**oXigen RF power amplifier**  
for SCP3 controller



73

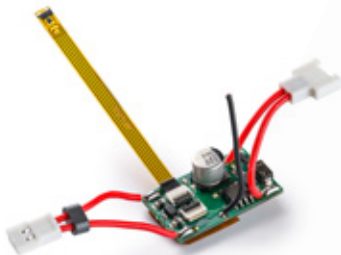

O201c1  
**oXigen chip** in-car controller



O201c-h  
**Hall sensor**  
for O2 chip "C" type (1x)



O204b  
**oXigen dongle**  
supplied not active, you must  
purchase the license with app



O201c-S04  
**Bay lid for O201c chip,**  
Scalextric DPR  
compatible hatch



CN11b - **Neodimium magnet**  
25x8x4mm magnet (2x)



SP32  
**Spare IR LED on wires**  
for oXigen and SSD chips



O203b  
**oXigen lane changer driver**  
for Ninco/Carrera

72

# Digital system

## SCP-2



SCP201d1

### SCP2 digital controller

for Carrera D132 and Scalextric SSD C7042

# Digital system



SP32

### Spare IR LED on wires

for oXigen and SSD chips

74



SCP201e1

### Digital cartridge controller

for Carrera D132 and Scalextric SSD C704



SP15d

### Hornby digital Chip

for Scalextric SSD C7042 or Arc Pro system

75



SP43

Carrera digital Chip for Carrera D132 system



SP46

### Cable twist

with connector for Carrera (3x)



SP47

Noise motor filter for O2/SSD/  
D132 in-car module (1x)



SP50

Set of clip chip holder (3x)

# Analog controller

## SCP2



SCP201ai  
**SCP-2 analog controller**  
home racing Replaces SCP201a  
and SCP201i



SCP201fg  
**SCP2 electronic controller analog**  
with Common Ground High Current  
Cartridge - For all slot cars



SCP201f  
**SCP2 Controller**  
without Cartridge



SCP201bc  
**Analog cartridge**  
for SCP-1, SCP-2 and SCP-3  
electronic controllers



SCP201g  
**SCP2 analog common ground**  
(positive wiring) high current  
cartridge 20a cont. - 40A peak



SCP204a-sh  
**Short stroke trigger for SCP2**

SCP304a-sh  
**Short stroke trigger for SCP3**



SCP204a  
**SCP2 Complete Trigger Set**

SCP304a  
**SCP3 Complete Trigger Set**



# Electronic controller

## Spare parts

SCP202a   
SCP202b   
SCP202e 

**Complete shell** (red, blue, lemon yellow)



SCP303a   
**Buttons Kit** (red)

SCP303b   
SCP303c   
**Buttons Kit**  
(blue, lemon yellow)



SCP302a   
**Complete shell** (yellow)



SCP04f  
**Replacement cable**  
for high current cartridge (2m)



SCP04c  
**Replacement fuses**  
for SCP 3. 15A - fast (5x)



SCP04e  
**Spare silicon cable**



# Lighting kit



SP42  
**Leds and cables**  
for lighting kits SP06 and SP16c



78 SP16c  
**Universal lighting kit**  
for analog, SSD Slot.it cars and oXigen



SP44  
**Universal light kit** for analog and digital

SP48  
**Spare flat cables**  
for SP44 (2x)



# Live Timing System

Supported by  
PC Lap Counter



TS01a  
**Live timing box**

Programmable  
in 10 languages



TS02a  
**Track interface**

79



TS02b  
**Track to telemetry cable**



TS03a  
**Sector time expansion cable**



FREE  
Live timing box PC  
interface software.



# D2A System



0206a  
**D2A box - Analog wireless system** with digital features

80



0208a  
**Analog wireless system** set with timing and digital features

# Prints & Posters

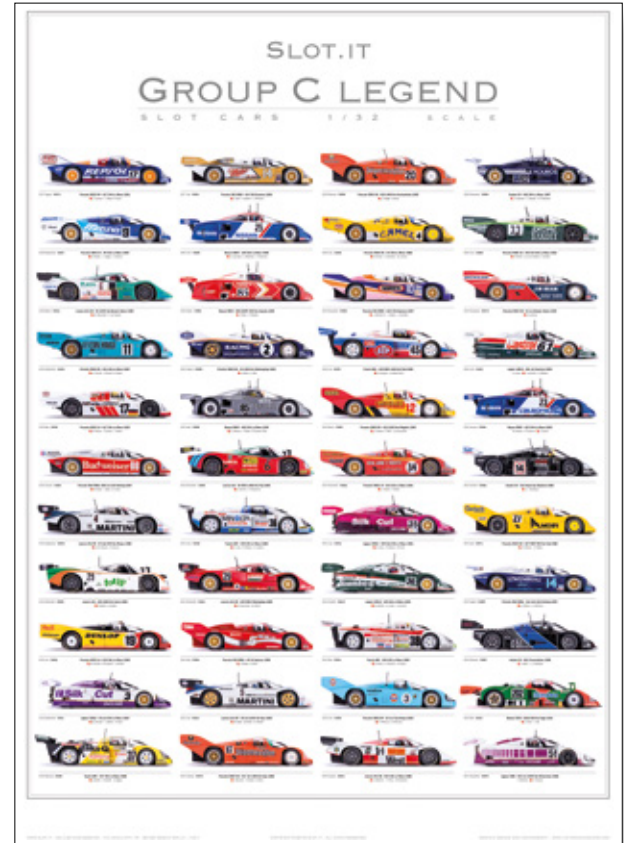

81

**PGRC-2**  
 Poster Slot.it  
 Group C Legend  
 (2011-2017)

**PGRC-2s**  
 Poster Slot it  
 Group C Legend  
 (2011-2017) - signed



**banner**  
 1m Slot.it banner (h 80cm)



**banner - oXigen**  
 2m oXigen banner (h 80cm)

# Maintenance



SP39  
**Gear grease**  
(15g)



SP40  
**Performance oil**  
for motors (20ml)



SP41  
**Motor cleaner and protector** (50ml)

# Common Parts



SP49  
**Set of rubber antennas** (2+2)

# 82 Packaging



SP09  
**Trasparent box**



SP36  
**Clamshell box**  
for 1:32 slot cars



SP35  
**Plastic spare parts containers**  
(d.17, h.50 mm)

# Distributors

## Italy

**Galileo Engineering srl**  
via Cavallotti 16  
42122 Reggio Emilia  
Italia  
Tel./Fax +39 0522 920496  
info@slot.it  
[www.slot.it](http://www.slot.it)

## Australia

**Armchair Racer**  
7/19 Hotham Parade  
Artarmon NSW 2064  
Australia  
Tel. +61 2 9906 5566  
cathy@armchairracer.com.au  
[www.armchairracer.com.au](http://www.armchairracer.com.au)

## Brazil

**B52 Modelismo**  
Rua Filinto de Almeida, 96  
Santo André - SP  
09190-020  
Brazil  
Tel. +5511 4425 2758  
b52grp7@gmail.com  
[www.b52online.com.br](http://www.b52online.com.br)

## Brunei

**Kingdom Rides & Adventures**  
unit 9, block A, Abraco  
Industrial Park, Simpang 281  
Lambak, Brunei BB1714  
Tel: +673 7114970  
info@mountainbikebrunei.com  
jason@mountainbikebrunei.com

## BeNeLux

**Q.U.I.C.K.**  
Victoria Regiastraat, 32  
1338 ZA - Almere  
Santiago - Chile  
Tel: +31 36 5370853  
fred.quick@upcmail.nl

## Chile

**Comercial Teba Limitada**  
**Jugueteria Alemana**  
Huerfanos 875 L 27  
Santiago - Chile  
Tel: 0056 226393359  
contacto@ja.cl  
[www.ja.cl](http://www.ja.cl)

## Czech Republic/ Slovakia

**Modelracing.cz s.r.o.**  
Tel: +420 475205600  
Mob: +420 775696300  
Mob: +420 736505354  
shop@modelracing.cz  
[www.modelracing.cz](http://www.modelracing.cz)

## France

**Fair International**  
24 rue Pasteur  
Za de Ragon  
44119 Treillieres  
Tel. +33 962 363409  
Mob. +33 613 501077  
Fax +33 240 592815  
fairslot@wanadoo.fr  
[www.fairslot.com](http://www.fairslot.com)

## Germany/ Austria

**H+T Motor Racing GmbH**  
Bert - Brecht - Strasse 43  
DE - 64291 Darmstadt  
Tel. +49 (0) 6150 84801  
Fax +49 (0) 6150 84803  
info@ht-motorracing.com  
[www.ht-autorennbahn.de](http://www.ht-autorennbahn.de)

## Greece

**Creative Hobby**  
17 Vrillission str.  
15236 Pendeli, Athens  
Greece  
Tel./Fax +30 210 6135518  
Mob. +30 6977204530  
nisko@creativehobby.gr  
[www.creativehobby.gr](http://www.creativehobby.gr)

## Japan

**Eyestec Co., Ltd**  
5-8-15Aihara, Midori-ku,  
Sagamihara, Kanagawa,  
252-0141 Japan  
Tel: +81-42-703-5585  
Fax: +81-42-703-5585  
sales@getslot.jp  
[www.getslot.jp](http://www.getslot.jp)

# Distributors

## New Zealand P.R.C.

### **Ironhorse Hobbies Ltd**

72 Treffers Road  
Wigram  
Christchurch 8042  
New Zealand  
Tel/Fax: +64 03 666 117  
sales@ironhorsehobbies.co.nz  
[www.ironhorsehobbies.co.nz](http://www.ironhorsehobbies.co.nz)

### **Ju Su Culture**

**Communication  
(Shanghai) Co.LTD**  
107, No. 671 Hutai Road,  
Jing'an District, Shanghai  
Tel. +86 13764621213  
speed-frontline@qq.com

## Singapore

### **InTrigg Hobbies**

62 Ubi Road 1.  
Oxley BizHub 2, #05-22.  
Singapore 408734.  
+65 8222-1330 (WhatsApp)  
www.intrigg-hobbies.com  
enquiries@intrigg-hobbies.com

## Switzerland

### **Ors Kart Racing**

Avenue des Pâquiers 22  
2072 Saint-Blaise  
Tel. +41 32 753 02 25  
scx@orskartesting.com  
[www.orskartesting.com](http://www.orskartesting.com)

## South Africa

### **Redipak Wholesalers**

Unit 5, 159 Greenvale Road  
Wilbart, Germiston,  
1609 Gauteng  
Rep. of South Africa  
Tel. +27 11 455 5990  
Fax +27 86 662 8613  
info@redipak.co.za  
[www.redipak.co.za](http://www.redipak.co.za)

## UK / Ireland

### **Gaugemaster Controls Ltd**

Gaugemaster House,  
Ford Road  
Arundel, West Sussex,  
BN18 0BN, United Kingdom  
Tel. +44 (0) 1903 884 321  
Fax +44 (0) 1903 884 377  
sales@gaugemaster.com  
[www.gaugemaster.com](http://www.gaugemaster.com)

## USA

### **Electric Dreams Slot Cars**

606 Hawaii St. Unit B  
El Segundo, CA 90245  
+1-310-676-7600  
shop@electricdreams.com  
[www.electricdreams.com](http://www.electricdreams.com)

# Stores

## Italy

### **bona.it**

Corso IV Novembre 69  
12042 Bra (CN)  
Tel. 0172753020  
bona@bona.it  
[www.bona.it](http://www.bona.it)

### **Bigi Modellismo**

Via Bernardino  
Zacchetti, 4,  
42124 Reggio  
Emilia RE  
[www.bigimodel.it](http://www.bigimodel.it)

### **Crazy4Slot**

Via del  
Cigno, 20  
61122 Pesaro (PU)  
Tel. +39 340 386 7130  
[www.crazy4slot.com](http://www.crazy4slot.com)

### **Franchi**

**di Scarpa Giuseppe**  
Via Padova 74,  
20132 Milano  
Tel. +39 02 2894967  
[www.franchidiscarpa.it](http://www.franchidiscarpa.it)

### **Hobbitalia 2 s.a.s.**

di Barthel Federico e C.  
via degli Artisti 11 d/e  
50132 Firenze  
tel. e fax +390555535499  
hobbitalia2@virgilio.it

### **Libreria Semola snc**

via De Amicis 5D  
42025 Cavriago (RE)  
Tel. +39 0522 371517  
info@librieriasemola.it  
[www.librieriasemola.it](http://www.librieriasemola.it)

### **Magic Model di Gardini Piero**

via Felice Orsini 22 47121 Forlì  
Telefono: 0543.27891  
mail: magic.model@tin.it  
[www.magic-model.it](http://www.magic-model.it)

### **Marzi Otello s.a.s.**

Piazza Filippo Carli, 19/20  
00191 - Roma - RM  
Tel: +39 06 3296455  
[www.slotcars.it](http://www.slotcars.it)

### **Modellismo Micro Macro snc**

viale del lavoro 47 - 37036  
San Martino Buon Albergo (VR)  
Tel. +39 045 994554  
[www.modellismoveronamicromacro.com](http://www.modellismoveronamicromacro.com)

### **Modellismo Uliano s.r.l.**

info@modellismouliano.com  
[www.modellismouliano.com](http://www.modellismouliano.com)

### **mondoslot**

Tel. 3289040615  
info@mondoslot.com  
[www.mondoslot.com](http://www.mondoslot.com)

### **Mularoni Marta Modellismo**

Contrada dei Magazzini 4/6  
47890 C. Storico San Marino, San Marino  
Tel.: +39 0549 991211  
[mularoni-marta-modellismo.business.site](http://mularoni-marta-modellismo.business.site)

### **Pit Stop Modellismo**

Via G. Graziani, 73  
41122 Modena  
Tel. e Fax 059/452054  
info@pitstopmodel.com  
[www.pitstopmodel.com](http://www.pitstopmodel.com)

### **Slotracingstore di Antonio Merlini**

Via Filippo Marchetti 19  
00199 Roma  
Tel: 3478184582  
[www.slotracingstore.com](http://www.slotracingstore.com)

### **Toptoy srls**

Via dei Granatieri, 3  
00143 Roma  
Tel. +39 0694375533  
team@toptoy-italy.com  
[www.toptoy-italy.com](http://www.toptoy-italy.com)

### **Tuttoslot Shop**

Tel. 339/2396365  
[noleggi.tuttoslot.it](http://noleggi.tuttoslot.it)

### **Wonderland Pavia Gilpavia srls**

Via Pietro Nenni, 72/a,  
27100 Pavia PV  
Tel.: +39 331 84 79 510  
[wonderland-pavia.business.site](http://wonderland-pavia.business.site)

# Stores

## BeNeLux

**Slotracing2go**  
info@slotracing2go.nl  
[www.slotracing2go.nl](http://www.slotracing2go.nl)

**Slotraceshop.nl**  
Lage Engweg 49A  
3882BC Putten  
tel. 0031341361185  
info@slotraceshop.nl  
[www.slotraceshop.nl](http://www.slotraceshop.nl)

## Canada

**Scale Racing  
Center Toronto**  
145 Claireport Crescent  
UNIT 5, Toronto, Ontario  
M9W 6R6  
Canada  
Tel: 416-886-4299  
emossetti@rogers.com

## Spain

**Cric Crac**  
[www.criccrac.com](http://www.criccrac.com)  
La Masia, 28  
(Ctra N-II Km 559)  
08711 Òdena (Igalada)  
Tel. +34 93 804 0015  
Whatsapp: +34 671 629 311

**Evotec Shop S.L.**  
+34 675 653 294  
info@evotecshop.com  
[www.evotecshop.com](http://www.evotecshop.com)

**Factory Slot**  
Km 345 Centro Comercial  
Factory Bonaire,  
ALDAIA, VALENCIA  
factoryslot@gmail.com

**Model Hobby Red**  
Calle Nuestra Señora  
de la Luz, n. 24  
28025 Madrid  
+34 611 107 335  
info@model-hobbyred.com  
[www.model-hobbyred.com](http://www.model-hobbyred.com)

**Slotforyou**  
Tel.: 935286016  
Móvil: 626584072  
[www.slotforyou.es](http://www.slotforyou.es)

**Slotmania**  
Calle Muntaner, 83  
CP: 08011 Barcelona  
(España)  
+34 934548686  
Whatsapp: +34 630272862  
info@grupslotmania.net  
[www.gruposlotmania.net](http://www.gruposlotmania.net)

**Speed Slot**  
Centro comercial Getafe 3  
avenida Juan Carlos I n.1  
28905 Getafe (Madrid)  
tel. 0034 619 24 62 48

## Denmark

**LP-Sales v/Per Springborg**  
Bakkevej 12  
DK-5450 Otterup  
Phone: (+45) 61553016  
lp-sales@mail.dk  
[www.dk-minirace.dk](http://www.dk-minirace.dk)

**Odsherreds  
Slot Car Shop**  
Tigervej 2  
4581 Rørvig, Denmark  
info@oscs.dk, FB: oscs.dk  
[www.oscs.dk](http://www.oscs.dk)

**Racerbaneshoppen.dk**  
Glerupvej 17  
DK-2610 Rødovre  
Phone: Per: +45 21734483  
salg@racerbaneshoppen.dk  
[www.racerbaneshoppen.dk](http://www.racerbaneshoppen.dk)

**SlotWorld.dk**  
Phone: +45 29 91 91 91  
mail@slotworld.dk  
[www.slotworld.dk](http://www.slotworld.dk)

## France

**Slot Car-Union**  
[www.slotcar-union.com](http://www.slotcar-union.com)

**Slot Car Boutique  
by SP Collectable**  
Mr Saioni Christopher  
2548 Rn7 Quartier  
Les Ristauds  
83170 Tourves  
Phone 04 94 77 25 08  
spcollectable@yahoo.fr  
[www.slotcar-boutique.com](http://www.slotcar-boutique.com)

## USA

**Electric Dreams Slot Cars**  
606 Hawaii St. Unit B El  
Segundo, CA 90245  
+1-310-676-7600  
shop@electricdreams.com  
[www.electricdreams.com](http://www.electricdreams.com)

**Great Traditions**  
13004 Kelvin Ave.  
Philadelphia, PA 19116  
Phone +1- 215-969-8694  
customer@gtslotcars.com  
[www.gtslotcars.com](http://www.gtslotcars.com)

**Professormotor Inc.**  
1235 Industrial Drive Suite 10  
Saline MI 48176  
professor@professormotor.com  
[www.professormotor.com](http://www.professormotor.com)

**Scale Auto Racing LLC**  
11303 Jones Rd West, Ste C  
Houston, Texas 77095  
+1-806-606-6710  
info@houstonsscaleautoracing.com  
sales@houstonsscaleautoracing.com  
[www.houstonsscaleautoracing.com](http://www.houstonsscaleautoracing.com)

**Scale Racing Center**  
3723 S Lawrence St  
Tacoma WA 98409  
tel. 1-253-564-1445  
[www.scaleracing.com](http://www.scaleracing.com)  
[www.132slotcar.us](http://www.132slotcar.us)

**LEB Hobbies, LLC**  
655 Leslie Lane  
Yardley, PA 19067  
215-493-4821  
sales@lebhobbies.com  
[www.lebhobbies.com](http://www.lebhobbies.com)

**Cincyslots**  
2172 Seymour Ave  
Cincinnati, Ohio 45237  
Phone +1-513-731-3304  
g2172@aol.com  
[cincyslots.com](http://cincyslots.com)

## UK

**Pendle Slot Racing**  
49 Churchill Way, Lomeshaye Ind Est,  
Nelson, Lancashire, BB9 6RT, UK  
info@pendleslotracing.co.uk  
[www.pendleslotracing.co.uk](http://www.pendleslotracing.co.uk)

**VRC Hobbies**  
78 Horseblock Rd. Unit 9  
Yaphank, NY 11980, USA  
+1-516-462-0696  
[www.vrchobbies.com](http://www.vrchobbies.com)

**Clover Leaf Racing**  
1246 South Milford Road  
Milford Michigan 48357  
313-473-SLOT  
cloverleafracing@gmail.com  
[www.cloverleafracing.com](http://www.cloverleafracing.com)

**Colpar's Hobbytown**  
1915 S Havana St  
Aurora, CO 80014  
+1-303-341-0414  
fred@colpar.com  
[www.hobbytown.com](http://www.hobbytown.com)

## Norway

**Bralek.no**  
Vinsvoldveien 3  
3302 Hokksund  
Tel: (+47)  
46908301  
post@bralek.no  
[www.bralek.no](http://www.bralek.no)

## Sweden

**Agico AB**  
Sandgatan 10  
247 62 VEBERÖD  
SWEDEN  
Phone: +46 730 584 995  
info@slotcar4fun.se  
[www.slotcar4fun.se](http://www.slotcar4fun.se)

## Portugal

**MeoSlot**  
Complexo industrial das  
eiras caminho da igreja n.24  
9125-138 caniço Madeira  
Portugal  
Tel: 00351291628823  
meoslot@gmail.com  
[www.meoslot.com](http://www.meoslot.com)

**Bromma Hobby AB**  
Krossgatan 25, 16250  
Vällingby.  
Tel. +46-(0)8 410 208 08  
info@brommahobby.se  
[www.brommahobby.com](http://www.brommahobby.com)

**SlotMadeira**  
sales@slotmadeira.pt  
MadSlot - Virgilio

**Fritsla Hobby + Hobbia**  
Bäckabovägen 5  
511 71 Fritsla  
Tel: +46 708570166  
info@hobbia.se  
hobbia.se





# Slot CARS

TRACK &  
ACCESSORIES

1:32·SCALE

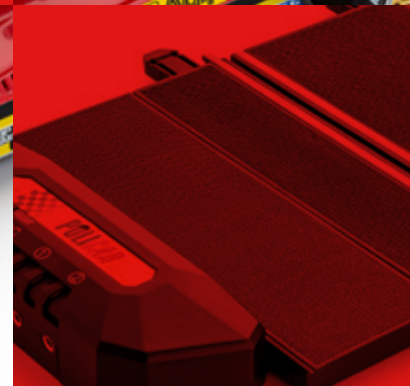

[policar.it](http://policar.it)

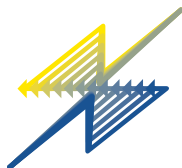

**Galileo  
Engineering**

Galileo Engineering srl  
via Cavallotti 16  
42122 Reggio Emilia, Italy  
E-mail: info@slot.it



## Index

4	CLASSIC F1 Spare Parts
10	LOTUS 72 Spare Parts
12	MARCH 701 Spare Parts
14	FERRARI 312 B2 Spare Parts
16	BRM P160/ P153 Spare Parts
18	FERRARI 126 C2 Spare Parts
19	MONOPOSTO 2018 Spare Parts
20	MONOPOSTO 2024 Spare Parts
21	CLASSIC F1 White Kit
22	TYRES & WHEELS
25	HOME RACERS Spare Parts
27	POLICAR TRACK



# CLASSIC F1 Spare Parts



**PCH01**  
F1 '70 narrow motor mount

**PCH03**  
'70 wide motor mount



**PCH08**  
F1 '80 narrow motor mount

**PCH09**  
F1 '80 wide motor mount

ONLY for CAR07  
an CAR10 cars



**PCH10** F1 motor mount for FLAT type motors



**PPI429o20-bg**  
9 teeth conical pinion internal  $\varnothing$ : 2mm (2x)

# CLASSIC F1 Spare Parts

Assembled F1 '70 narrow  
motor mount with bevel gears



- PCH01-45z15** ● axle 45mm, Z15 crown,  $\varnothing$ 6,84 mm
- PCH01-45z16a** ○ axle 45mm, Z16 crown,  $\varnothing$ 7,22 mm
- PCH01-45z17** ● axle 45mm, Z17 crown,  $\varnothing$ 7,6 mm
- PCH01-45z18** ● axle 45mm, Z18 crown,  $\varnothing$ 7,6 mm
- PCH01-45z18a** ● axle 45mm, Z18 crown,  $\varnothing$ 7,95 mm
- PCH01-51z15** ● axle 51mm, Z15 crown,  $\varnothing$ 6,84 mm
- PCH01-51z16a** ○ axle 51mm, Z16 crown,  $\varnothing$ 7,22 mm
- PCH01-51z17** ● axle 51mm, Z17 crown,  $\varnothing$ 7,6 mm
- PCH01-51z18** ● axle 51mm, Z18 crown,  $\varnothing$ 7,6 mm
- PCH01-51z18a** ● axle 51mm, Z18 crown,  $\varnothing$ 7,95 mm
- PCH01-54z15** ● axle 54mm, Z15 crown,  $\varnothing$ 6,84 mm
- PCH01-54z16a** ○ axle 54mm, Z16 crown,  $\varnothing$ 7,22 mm
- PCH01-54z17** ● axle 54mm, Z17 crown,  $\varnothing$ 7,6 mm
- PCH01-54z18a** ● axle 54mm, Z18 crown,  $\varnothing$ 7,95 mm

Assembled F1 '70 wide motor  
mount with bevel gears



- PCH03-45z15** ● axle 45mm, Z15 crown,  $\varnothing$ 6,84 mm
- PCH03-45z16a** ○ axle 45mm, Z16 crown,  $\varnothing$ 7,22 mm
- PCH03-45z17** ● axle 45mm, Z17 crown,  $\varnothing$ 7,6 mm
- PCH03-45z18** ● axle 45mm, Z18 crown,  $\varnothing$ 7,6 mm
- PCH03-45z18a** ● axle 45mm, Z18 crown,  $\varnothing$ 7,95 mm
- PCH03-51z15** ● axle 51mm, Z15 crown,  $\varnothing$ 6,84 mm
- PCH03-51z16a** ○ axle 51mm, Z16 crown,  $\varnothing$ 7,22 mm
- PCH03-51z17** ● axle 51mm, Z17 crown,  $\varnothing$ 7,6 mm
- PCH03-51z18** ● axle 51mm, Z18 crown,  $\varnothing$ 7,6 mm
- PCH03-51z18a** ● axle 51mm, Z18 crown,  $\varnothing$ 7,95 mm
- PCH03-54z15** ● axle 54mm, Z15 crown,  $\varnothing$ 6,84 mm
- PCH03-54z16a** ○ axle 54mm, Z16 crown,  $\varnothing$ 7,22 mm
- PCH03-54z17** ● axle 54mm, Z17 crown,  $\varnothing$ 7,6 mm
- PCH03-54z18a** ● axle 54mm, Z18 crown,  $\varnothing$ 7,95 mm

# CLASSIC F1 Spare Parts

Assembled F1 '80 narrow motor mount with bevel gears



- PCH08-45z15** ● axle 45mm, Z15 crown, Ø6,84 mm
- PCH08-45z16a** ○ axle 45mm, Z16 crown, Ø7,22 mm
- PCH08-45z17** ● axle 45mm, Z17 crown, Ø7,6 mm
- PCH08-45z18** ● axle 45mm, Z18 crown, Ø7,6 mm
- PCH08-45z18a** ● axle 45mm, Z18 crown, Ø7,95 mm
- PCH08-51z15** ● axle 51mm, Z15 crown, Ø6,84 mm
- PCH08-51z16a** ○ axle 51mm, Z16 crown, Ø7,22 mm
- PCH08-51z17** ● axle 51mm, Z17 crown, Ø7,6 mm
- PCH08-51z18** ● axle 51mm, Z18 crown, Ø7,6 mm
- PCH08-51z18a** ● axle 51mm, Z18 crown, Ø7,95 mm
- PCH08-54z15** ● axle 54mm, Z15 crown, Ø6,84 mm
- PCH08-54z16a** ○ axle 54mm, Z16 crown, Ø7,22 mm
- PCH08-54z17** ● axle 54mm, Z17 crown, Ø7,6 mm
- PCH08-54z18** ● axle 54mm, Z18 crown, Ø7,6 mm
- PCH08-54z18a** ● axle 54mm, Z18 crown, Ø7,95 mm

Assembled F1 '80 wide motor mount with bevel gears



- PCH09-45z15** ● axle 45mm, Z15 crown, Ø6,84 mm
- PCH09-45z16a** ○ axle 45mm, Z16 crown, Ø7,22 mm
- PCH09-45z17** ● axle 45mm, Z17 crown, Ø7,6 mm
- PCH09-45z18** ● axle 45mm, Z18 crown, Ø7,6 mm
- PCH09-45z18a** ● axle 45mm, Z18 crown, Ø7,95 mm
- PCH09-51z15** ● axle 51mm, Z15 crown, Ø6,84 mm
- PCH09-51z16a** ○ axle 51mm, Z16 crown, Ø7,22 mm
- PCH09-51z17** ● axle 51mm, Z17 crown, Ø7,6 mm
- PCH09-51z18** ● axle 51mm, Z18 crown, Ø7,6 mm
- PCH09-51z18a** ● axle 51mm, Z18 crown, Ø7,95 mm
- PCH09-54z15** ● axle 54mm, Z15 crown, Ø6,84 mm
- PCH09-54z16a** ○ axle 54mm, Z16 crown, Ø7,22 mm
- PCH09-54z17** ● axle 54mm, Z17 crown, Ø7,6 mm
- PCH09-54z18** ● axle 54mm, Z18 crown, Ø7,6 mm
- PCH09-54z18a** ● axle 54mm, Z18 crown, Ø7,95 mm

# CLASSIC F1 Spare Parts

Assembled F1 motor mount for flat type motors with bevel gears



- PCH10-51z15** ● axle 51mm, Z15 crown, Ø6,84 mm
- PCH10-51z16** ○ axle 51mm, Z16 crown, Ø7,22 mm
- PCH10-51z17** ● axle 51mm, Z17 crown, Ø7,6 mm
- PCH10-51z18** ● axle 51mm, Z18 crown, Ø7,95 mm

## Gear Ratios

Optional Z9 pinion	Z25-15 (PGI2515-bg)	Z18 (PGS7918-..)
25/15 teeth - Z18 New Gear Ratio <b>3.34</b>		
Optional On production models	Z25-16 (PGI2516-bg)	Z17 (PGS8017-..)
25/16 teeth - Z17 STD Gear Ratio <b>2.94</b>		
Optional Z9 pinion	Z25-17 (PGI2517-bg)	Z16 (PGS7216-..)
25/17 teeth - Z16 New Gear Ratio <b>2.61</b>		
Optional Z9 pinion	Z25-18 (PGI2518-bg)	Z15 (PGS6815-..)
25/18 teeth- Z15 New Gear Ratio <b>2.30</b>		



# CLASSIC F1 Spare Parts

**PMX01** F1 DFV-25K RPM  
motor dual open/closed case sides



**PPI429o15** 9 teeth pinion,  
external  $\varnothing$ :4.2 mm  
internal  $\varnothing$ :1.5 mm, brass (2x)



**PMX01-k** F1 DFV-25K RPM  
motor dual o/c case sides, knurled shaft



**PPI429o15-bg** 9 teeth pinion,  
conical pinion internal  $\varnothing$ :1.5 mm (2x)



**PGI2515-bg** F1 plastic bevel gear  
with axle and spacer, Z25/Z15



**PGI2516-bg** F1 plastic bevel gear  
with axle and spacer, Z25/Z16



**PGI2517-bg** F1 plastic bevel gear  
with axle and spacer, Z25/Z17



**PGI2518-bg** F1 plastic bevel gear  
with axle and spacer, Z25/Z18



**PPA01** Set of 4 bushings  
for F1 motor mounts



**PPA02** Stopper  
with M2xL2 mm hexagonal screw



**PCH04** Motor mount screws  
M1.4 x 2.5 mm, 4pcs.



**PCH05** Metric screws  
M2 x 3.8 mm, brass, (5x)



**PCH06** Metric screws  
M2 x 7mm, brass, (5x)



**PCH07** Metric screws  
M2 x 5 mm, brass, (5x)



**PGS6815-45**  $\varnothing$ 6,84 mm, 15 teeth gear with 45mm axle

**PGS7216-45**  $\varnothing$ 7,22 mm, 16 teeth gear with 45mm axle

**PGS7617-45**  $\varnothing$ 7,6 mm, 17 teeth gear with 45mm axle

**PGS7918-45**  $\varnothing$ 7,95 mm, 18 teeth gear with 45mm axle

**PGS8016-45**  $\varnothing$ 7,6 mm, 16 teeth gear with 45mm axle

**PGS8018-45**  $\varnothing$ 7,6 mm, 18 teeth gear with 45mm axle

**PGS6815-51**  $\varnothing$ 6,84 mm, 15 teeth gear with 51mm axle

**PGS7216-51**  $\varnothing$ 7,22 mm, 16 teeth gear with 51mm axle

**PGS7617-51**  $\varnothing$ 7,6 mm, 17 teeth gear with 51mm axle

**PGS7918-51**  $\varnothing$ 7,95 mm, 18 teeth gear with 51mm axle

**PGS8016**  $\varnothing$ 7,6 mm, 16 teeth gear with 51mm axle

**PGS8018**  $\varnothing$ 7,6 mm, 18 teeth gear with 51mm axle

**PGS6815-54**  $\varnothing$ 6,84 mm, 15 teeth gear with 54mm axle

**PGS7216-54**  $\varnothing$ 7,22 mm, 16 teeth gear with 54mm axle

**PGS7617-54**  $\varnothing$ 7,6 mm, 17 teeth gear with 54mm axle

**PGS7918-54**  $\varnothing$ 7,95 mm, 18 teeth gear with 54mm axle

**PGS8016-54**  $\varnothing$ 7,6 mm, 16 teeth gear with 54mm axle

**PGS8018-54**  $\varnothing$ 7,6 mm, 18 teeth gear with 54mm axle

# LOTUS 72 Spare Parts



**PCS02t**  
Lotus 72 chassis

---



**PCS02i**  
Lotus 72 wheels inserts (2x + 2x)

---



**PCS02p2** Lotus 72 spare parts B

---



**PCS02b1**  
Lotus 72 body (type A)

---



**PCS02b2**  
Lotus 72 body (type B)

---



**PCS02p3** Lotus 72 spare parts C

---



**PCS02v** Lotus 72 transparent parts

---

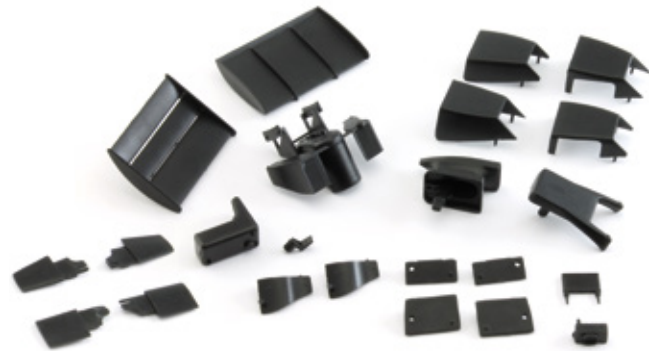

**PCS02p1** Lotus 72 spare parts A

---



**PCS02p4** Lotus 72 spare parts D

---

# MARCH 701 Spare Parts



**PCS04t-a** March 701 chassis

---



**PCS04p1** March 701 spare parts A

---



12 **PCS04i** March 701 wheel inserts (2x + 2x)

---

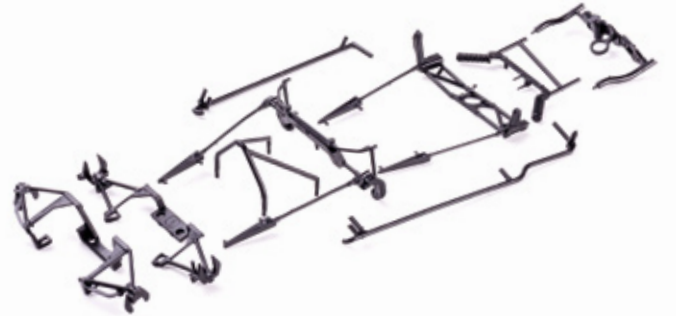

**PCS04p2** March 701 spare parts B

---



**PCS04b** March 701 body

---



**PCS04v** March 701 transparent parts

---

# FERRARI 312 B2

## Spare Parts



**PCS05t1**  
312B2 chassis type 2



**PCS05b2**  
312B2 body type 2



**PCS05p2** 312B2 spare parts B



**PCS05p3** 312B2 spare parts C



**PCS05t2**  
312B2 chassis type 1



**PCS05b1**  
312B2 body type 1



**PCS05v**  
312B2 transparent parts



**PCS05p1**  
312B2 spare parts A



**PCS05i** 312B2 kit wheel inserts (2+2+2)



# BRM P160/P153

## Spare Parts



**PCS08v** P160/P153 transparent parts

---



**PCS08b** 160 body

---



**PCS08t** P160/P153 chassis

---



**PCS08i** P160/P153 kit wheel inserts (4+4+2)

---



**PCS08p1** P160/P153 spare parts type A

---



**PCS08p2** P160 spare parts type B

---



**PCS08p3** P153 spare parts type B

---

# FERRARI 126 C2

## Spare Parts



**PCS09p1**  
126 C2 spare parts A



**PCS09p2**  
126 C2 spare parts B



**PCS09v**  
126 C2 transparent parts



**PCS09b**  
126 C2 body



**PCS09t**  
126 C2 chassis



**PCS09i**  
126 C2 wheel insert (2x + 2x)

# MONOPOSTO 2018

## Spare Parts



**PCS07t1a**  
Monoposto chassis  
standard rev1



**PCS07t2a**  
Monoposto chassis  
digital version rev1



**PCS07p**  
Monoposto spare parts



**PCS07p1**  
Monoposto  
front wing clips (12x)



**PCS07p2**  
Monoposto front  
suspension set



**PCS07i**  
Monoposto kit  
wheel inserts (2+2)



**PCS07b** Monoposto body kit

# MONOPOSTO 2024

## Spare Parts



**PCS10t** Monoposto '24 chassis



**PCS10b** Monoposto '24 body



**PCS10p** Monoposto '24 spare parts



**PCS10i** Monoposto '24 wheel inserts (2+2)

# CLASSIC F1 White kit

(not assembled)



**CAR02z**  
Lotus 72 white kit

**CAR04z1**  
March 701 white kit

**CAR05z**  
312B2 white kit

**CAR05z1**  
312B2 white kit type 2

**CAR08z1**  
P160 white kit

**CAR08z2**  
P153 white kit

**CAR09z**  
126 C2 white kit

# CARS Spare Parts

	MODEL		
	312PB	F40	330 P4/412P
<b>CODE</b>	CAR01	CAR03	CAR06
<b>CHASSIS</b>	PCS01t	PCS03t	PCS06t
<b>SPARE PARTS</b>	PCS01p	PCS03p	PCS06p
<b>TRANSPARENT PARTS</b>	PCS01v	PCS03v	PCS06v
<b>WHEEL INSERTS</b>	PCS01i	-	PCS06i
<b>WHITE KIT</b>	-	-	CAR06z
<b>BODY KIT</b>	KIT01	-	PCS06b
<b>COCKPIT</b>	-	PCS03cp	PCS06lx

# TYRES & WHEELS

Rear Ø 16mm (Classic formula)



## PPT1219C1

C1 compound,  
F1 rear tyre for Ø16mm (eq. 15") wheels (4x)

---



## PPT1310F22 PPT1310G25 PPT1310C1

F22-G25-C1 compound,  
F1 rear tyre, slick, for Ø16mm (eq. 15") wheels (4x)

---



## PW16011724P

ex PWH1217-PI  
PI Ø16x11.7mm F1 rear wheels, 0.8g (4x) – eq. 15"

---



## PW16011724A

ex PWH1234-AI  
AI Ø16x11.7mm F1 rear wheels, M2 grub, 1.8g (2x) – eq. 15"

---

# TYRES & WHEELS

Front Ø 13.8mm (Classic formula)



## PPT1220C1

C1 compound,  
F1 front tyre for Ø13.8mm wheels (4x)

---



## PW13807921P

ex PWH1218-PI  
PI Ø13.8x7.9mm F1 front wheels, 0.5g (4x)

---

Rear Ø 13.8mm (Classic & Monoposto 2018)



## PPT1224F22 PPT1224G25 PPT1224C1

F22-G25-C1 compound,  
F1 rear tyre, slick, for Ø13.8mm (eq. 13") wheels (4x)

---



## PW13813519P

PI Ø13.8x13.5mm F1 rear wheels, 0.5g (4x) – eq. 13"

---



## PW13813519A

AI Ø13.8x13.5mm F1 rear wheels, M2 grub, 1.8g (2x) – eq. 13"

---



# TYRES & WHEELS

Front Ø 13.8mm (Monoposto 2018)



**PPT1354C1**

C1 compound,  
F1 front tyre for Ø13.8mm wheels (4x)

---



**PW13810504P**

PI Ø13.8x10.5mm F1 front wheels, 0.5g (4x)

---

Rear Ø 17.3mm (Monoposto 2024)



**PPT1405G25**

**PPT1405F22**

**PPT1405C1**

G25-F22-C1 compound,  
F1 rear tyre, slick, for Ø17.3mm (eq. 18") wheels (4x)

---



**PW17313515A**

Al Ø17.3x13.5mm F1 rear wheels, M2 grub, 1.8 (2x) - eq. 18"

---

# HOME RACERS

## Spare Parts



**HR01**

Pickup set for Home Racers car

---



**HR02**

Copper braids for Home Racers car (4x)

---



**HR03**

GT86 spare chassis

---



**HR04**

Polycarbonate cockpit for Policar Toyota GT86 - CT01

---

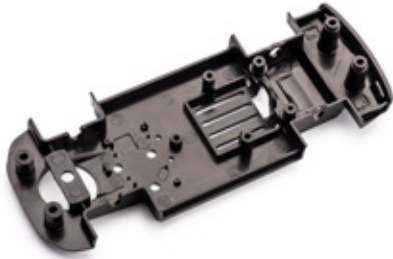

**HR05**  
WRX STI spare chassis

---



**HR06**  
Polycarbonate cockpit for WRX STI - CT02

---



**HR07**  
GT4 spare chassis

---



**HR08**  
V12 13.6K RPM motor 60g\*cm  
spare motor for 'CT' cars

---



**HR09**  
Rear mirrors set  
for 'CT' cars

---

POLICAR, the brand that was synonym of slot car racing in Italy in the 60's, returns with innovative solutions for a completely new track system. POLICAR's new design and ideas bring back the fun and excitement of slot car racing! Lanes are set apart by 9 cm, the ideal lane spacing for 1/32 racing, and the surface texture is good for rubber and sponge tyres alike. The 6 cm extra wide borders slide securely into the side of the track, and the guardrails are kept firmly in place. Bridges and ramps are easy and stable. Rails are made of stainless steel.



# POLICAR TRACK

## Racing Track System



**P008-4**  
Full length straight, 358mm (4x)

---



**P091-4**  
Single lane half length  
straight, 179mm (4x)

---



**P002-6**  
Straight border, 179mm (6x)

---

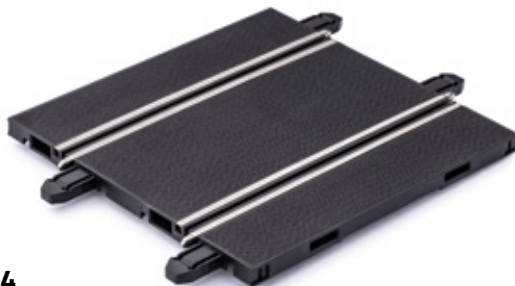

**P023-4**  
Half length straight, 179mm (4x)

---



**P015-1**  
Analog powerbase with border for lane 1 and 2 (1x)

---

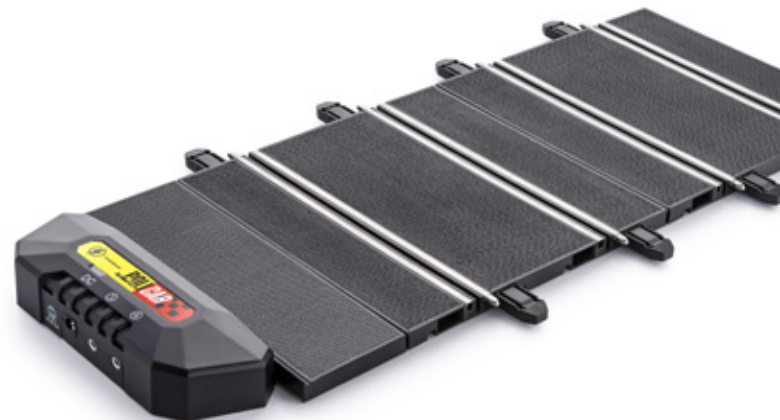

**P016-1**  
Analog powerbase with border for lane 3 and 4 (1x)

---



**P092-4**

Single lane 61.4 length  
straight, 61.4mm (4x)

---



**P024-4**

61.4 length straight, 61.4mm (4x)

---

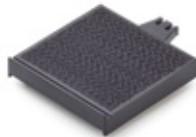

**P061-6**

61.4 straight border, 61.4mm (6x)

---



**P046-2**

Polistil & Fleischmann  
adapter, 61.4mm (2x)

---



**P059-6**

End border left (6x)

---



**P060-6**

End border right (6x)

---



**P075-10**

Locking clips for curves (10x)

---



**P074-10**

Locking clips for straights (10x)

---



**P076-20**

Intersection  
locking clips (20x)

---





**P006-2**  
Ninco adapter, 179mm (2x)

---



32 **P007-4**  
Spare clips for Ninco adapter (4x)

---



**P009-4**  
R1 45° Curve (4x)

---



**P051-6**  
Inner border for R1 curve  
22.5° (6x)

---



**P053-6**  
Outer border for R1 curve  
22.5° (6x)

---



**P013-4**  
R1 22.5° Curve (4x)

---



**P014-2**  
R2 45° Curve (2x)

---



**P052-6**  
Inner border for R2 curve  
22.5° (6x)

---



**P054-6**  
Outer border for R2 curve  
22.5° (6x)

---



**P043-2**  
R2 22.5° Curve (2x)

---



**P044-2**  
R3 22.5° Curve (2x)

---



**P077-4**  
R5 11.25° Curve (4x)

---



**P055-6**  
Inner border for R3 curve  
22.5° (6x)

---



**P056-6**  
Outer border for R3 curve  
22.5° (6x)

---



**P071-6**  
Inner border for R5 curve  
11.25° (6x)

---



**P072-6**  
Outer border for R5 curve  
11.25° (6x)

---



**P045-2**  
R4 22.5° Curve (2x)

---



**P057-6**  
Inner border for R4 curve  
22.5° (6x)

---



**P058-6**  
Outer border for R4 curve  
11.25° (6x)

---



**P090-1**  
oXigen double lane changer 716mm (1x)

---

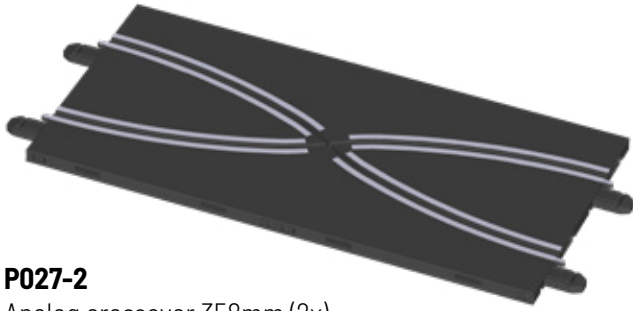

**P027-2**  
Analog crossover 358mm (2x)

---

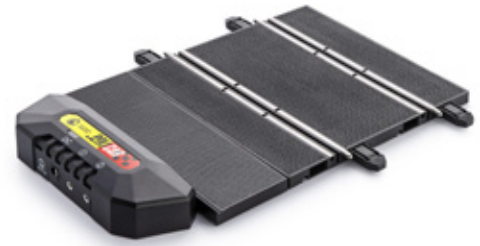

**P096-1**  
2 lanes lap counter with bluetooth module (1x)

---

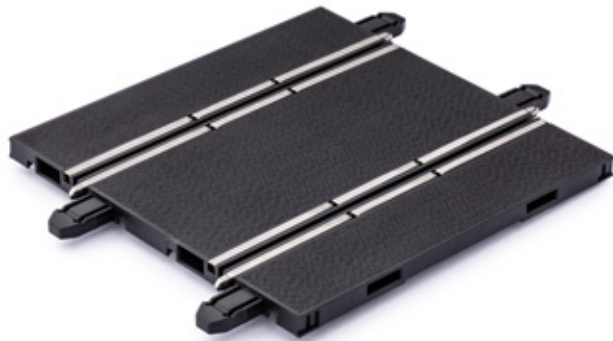

**P098-1**  
2 lanes dead strip with cables 179mm (1x)

---



**P099-1**  
Policar spring rails set (8+8x, spring length 1m)

---

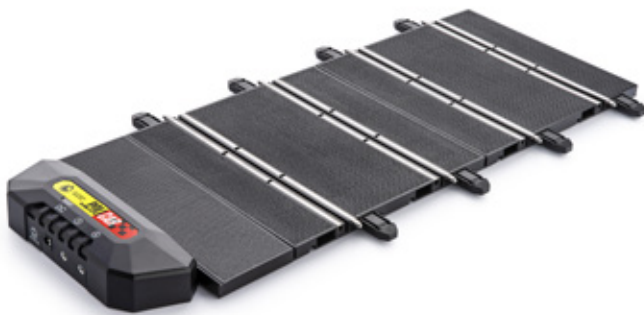

**P097-1**  
4 lanes lap counter with bluetooth module (1x)

---



**P030-10**  
Contact springs with fastons for Policar track (10+10x)

---



**P020-10**

Guardrail 25cm white - 10pcs

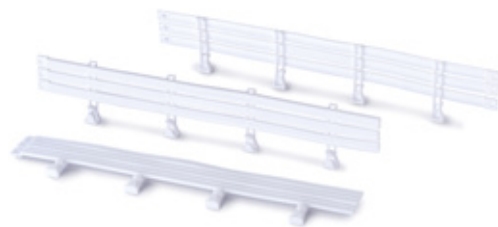

**P020g-10**

Guardrail 25cm grey - 10pcs



38



**P073-6**

1m Barrier and clips set (6x)  
"To use without borders"



**P010-4**

Bridge set (4x)

39



**P-Banner-W**



**P-Banner-B**



**P003EU-1**

5-13.5V adjustable  
power supply - EU

**P003US-1**

5-13.5V adjustable  
power supply - US

**P003UK-1**

5-13.5V adjustable  
power supply - UK

**P003AU-1**

12V power supply - AU



**T002z / T002z-UK / T002z-AU / T002z-US**

6.6m 2 lanes starter set - 2.5x1.6m assembled dimensions



**P029-1**

Black controller (1x)



**P028-1**

Red controller (1x)



**T003z / T003z-UK / T003z-AU / T003z-US**

6.5m 4 lanes starter set - 2.9x1.8m assembled dimensions



**P018-1a**

Banana to 3.5mm  
stereo jack adapter



**P019-1**

Polarity inversion cable



**T004z / T004z-UK / T004z-AU / T004z-US**

9.2m 4 lanes starter set - 3.8x2.2m assembled dimensions